

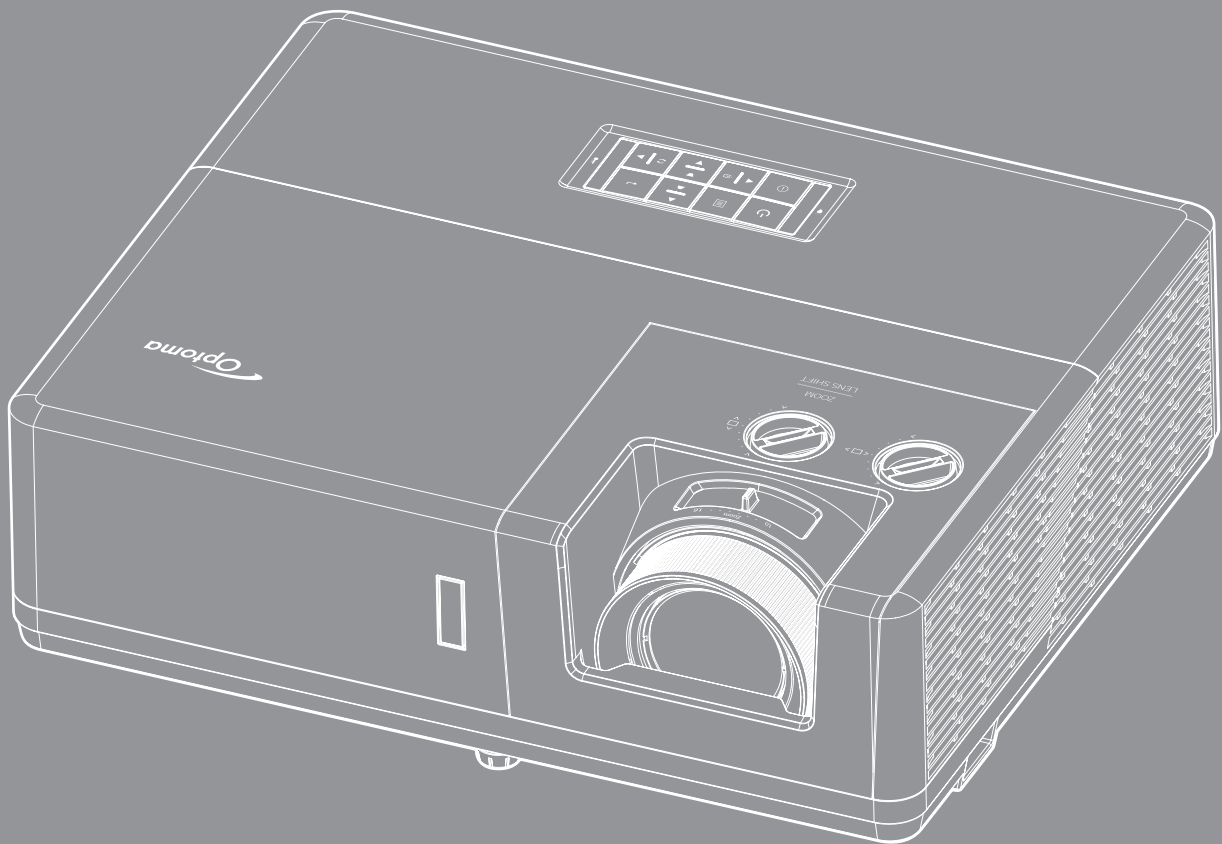

DLP® Projector



User manual





TABLE OF CONTENTS

SAFETY	4
<i>Important Safety Instruction</i>	4
<i>Cleaning the Lens</i>	6
<i>Laser Radiation Safety Information</i>	6
<i>Copyright</i>	7
<i>Disclaimer</i>	7
<i>Trademark Recognition</i>	7
<i>FCC</i>	7
<i>Declaration of Conformity for EU countries</i>	8
<i>WEEE</i>	8
INTRODUCTION	9
<i>Package Overview</i>	9
<i>Standard accessories</i>	9
<i>Product Overview</i>	10
<i>Connections</i>	12
<i>Keypad</i>	12
<i>Remote control</i>	13
SETUP AND INSTALLATION	14
<i>Installing the projector</i>	14
<i>Connecting sources to the projector</i>	16
<i>Adjusting the projector image</i>	17
<i>Remote setup</i>	20
USING THE PROJECTOR	22
<i>Powering on / off the projector</i>	22
<i>Selecting an input source</i>	23
<i>Menu navigation and features</i>	24
<i>OSD Menu tree</i>	25
<i>Image menu</i>	32
<i>Display menu</i>	36
<i>Setup menu</i>	41
<i>Input menu</i>	44
<i>Audio menu</i>	46
<i>Control menu</i>	47
<i>Information menu</i>	58

ADDITIONAL INFORMATION..... 59

<i>Compatible resolutions</i>	59
<i>Image size and projection distance</i>	64
<i>Projector dimensions and ceiling mount installation</i>	67
<i>IR remote codes</i>	68
<i>Troubleshooting</i>	70
<i>Warning indicators</i>	72
<i>Specifications</i>	73
<i>Optoma global offices</i>	75

SAFETY

	The lightning flash with arrow head within an equilateral triangle is intended to alert the user to the presence of uninsulated "dangerous voltage" within the product's enclosure that may be of sufficient magnitude to constitute a risk of electric shock to persons.
	The exclamation point within an equilateral triangle is intended to alert the user to the presence of important operating and maintenance (servicing) instructions in the literature accompanying the appliance.

Please follow all warnings, precautions and maintenance as recommended in this user's guide.

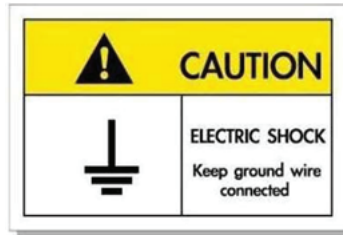

To avoid electric shock, the unit and its peripherals must be properly grounded (earthed).

Important Safety Instruction



- As with any bright source, do not stare into the direct beam, RG2 IEC 62471-5:2015.
- This projector is class 1 laser product of IEC/EN 60825-1:2014 and risk group 2 with the requirements of IEC 62471-5:2015.
- Supervise children: no staring, and avoid use of optical aids!
- Notice is given to supervise children and to never allow them to stare into the projector beam at any distance from the projector.
- Notice is given to use caution when using the remote control for starting the projector while in front of the projection lens.
- Notice is given to the user to avoid the use of optical aids such as binoculars or telescopes inside the beam.
- Do not block any ventilation openings. To ensure reliable operation of the projector and to protect from over heating, it is recommended to install the projector in a location that does not block ventilation. As an example, do not place the projector on a crowded coffee table, sofa, bed, etc. Do not put the projector in an enclosure such as a book case or a cabinet that restricts air flow.
- To reduce the risk of fire and/or electric shock, do not expose the projector to rain or moisture. Do not install near heat sources such as radiators, heaters, stoves or any other apparatus such as amplifiers that emits heat.
- Do not let objects or liquids enter the projector. They may touch dangerous voltage points and short out parts that could result in fire or electric shock.
- Do not use under the following conditions:
 - In extremely hot, cold or humid environments.
 - (i) Ensure that the ambient room temperature is within 0°C ~ 40°C
 - (ii) Relative humidity is up to 80%
 - In areas susceptible to excessive dust and dirt.
 - Near any appliance generating a strong magnetic field.
 - In direct sunlight.

- Do not use the unit if it has been physically damaged or abused. Physical damage/abuse would be (but not limited to):
 - Unit has been dropped.
 - Power supply cord or plug has been damaged.
 - Liquid has been spilled on to the projector.
 - Projector has been exposed to rain or moisture.
 - Something has fallen in the projector or something is loose inside.
- Do not place the projector on an unstable surface. The projector may fall over resulting in injury or the projector may become damaged.
- Do not block the light coming out of the projector lens when in operation. The light will heat the object and may melt, cause burns or start a fire.
- Please do not open or disassemble the projector as this may cause electric shock.
- Do not attempt to service the unit yourself. Opening or removing covers may expose you to dangerous voltages or other hazards. Please call Optoma before you send the unit for repair.
- See projector enclosure for safety related markings.
- The unit should only be repaired by authorized service personnel.
- Only use attachments/accessories specified by the manufacturer.
- Do not look into straight into the projector lens during operation. The bright light may harm your eyes.
- This projector will detect the life of the light source itself.
- When switching the projector off, please ensure the cooling cycle has been completed before disconnecting power. Allow 90 seconds for the projector to cool down.
- Turn off and unplug the power plug from the AC outlet before cleaning the product.
- Use a soft dry cloth with mild detergent to clean the display housing. Do not use abrasive cleaners, waxes or solvents to clean the unit.
- Disconnect the power plug from AC outlet if the product is not being used for a long period of time.
- Do not setup the projector in places where it might be subjected to vibration or shock.
- Do not touch the lens with bare hands.
- Remove battery/batteries from remote control before storage. If the battery/batteries are left in the remote for long periods, they may leak.
- Risk of fire or explosion if the battery is replaced by an incorrect type.
- Do not use or store the projector in places where smoke from oil or cigarettes may be present, as it can adversely affect the quality of the projector performance.
- Please follow the correct projector orientation installation as non standard installation may affect the projector performance.
- Use a power strip and or surge protector. As power outages and brown-outs can KILL devices.

Cleaning the Lens

- Before cleaning the lens, be sure to turn off the projector and unplug the power cord to allow it to completely cool down.
- Use a compressed air tank to remove the dust.
- Use a special cloth for cleaning lens and gently wipe the lens. Do not touch the lens with your fingers.
- Do not use alkaline/acid detergents or volatile solvents such as alcohol for cleaning lens. If the lens is damaged due to the cleaning process, it is not covered by the warranty.



Warning: Do not use a spray containing flammable gases to remove dust or dirt from the lens. This may cause a fire due to excessive heat inside the projector.



Warning: Do not clean the lens if the projector is warming up as this may cause the lens' surface film to peel off.



Warning: Do not wipe or tap the lens with a hard object.

Laser Notice

IEC 60825-1:2014/EN 60825-1+A11/EN50689:2021 CLASS 1 CONSUMER LASER PRODUCT, IEC 62471-5:2015 RISK GROUP 2.

The product's intended use as a consumer laser product and compliant with EN 50689:2021.

CLASS 1 CONSUMER LASER PRODUCT

EN 50689:2021

Laser Radiation Safety Information

- Complies with 21 CFR 1040.10 and 1040.11 except for conformance as a Risk Group 2 LIP as defined in IEC 62471-5:Ed. 1.0. For more information see Laser Notice No. 57, dated May 8, 2019.
- IEC 60825-1:2014/EN 60825-1+A11/EN50689:2021 CLASS 1 CONSUMER LASER PRODUCT, IEC 62471-5:2015 RISK GROUP 2

IEC 60825-1:2014, EN 60825-1:2014+A11:2021, EN 50689:2021 CLASS 1 CONSUMER LASER PRODUCT RISK GROUP 2, Complies with 21 CFR 1040.10 and 1040.11 except for conformance as a Risk Group 2 LIP as defined in IEC 62471-5:Ed.1.0. For more information see Laser Notice No. 57, dated May 8, 2019.
IEC 60825-1:2014 等級1雷射產品RG2危險等級
IEC 60825-1:2014 1類激光產品RG2危險等級

- When turning on the projector, make sure no one within projection range is looking at the lens.
- Keep any items (magnifying glass etc.) out of the light path of the projector. The light path being projected from the lens is extensive, therefore any kind of abnormal objects that can redirect light coming out of the lens, can cause an unpredictable outcome such as a fire or injury to the eyes.
- Any operation or adjustment not specifically instructed by the user's guide creates the risk of hazardous laser radiation exposure.
- Do not open or disassemble the projector as this may cause damage by the exposure of laser radiation.
- Do not stare into beam when the projector is on. The bright light may result in permanent eye damage.

Not following the control, adjustment or operation procedure may cause damage by the the exposure of laser radiation.

Copyright

This publication, including all photographs, illustrations and software, is protected under international copyright laws, with all rights reserved. Neither this manual, nor any of the material contained herein, may be reproduced without written consent of the author.

© Copyright 2023

Disclaimer

The information in this document is subject to change without notice. The manufacturer makes no representations or warranties with respect to the contents hereof and specifically disclaims any implied warranties of merchantability or fitness for any particular purpose. The manufacturer reserves the right to revise this publication and to make changes from time to time in the content hereof without obligation of the manufacturer to notify any person of such revision or changes.

Trademark Recognition

Kensington is a U.S. registered trademark of ACCO Brand Corporation with issued registrations and pending applications in other countries throughout the world.

HDMI, the HDMI Logo, and High-Definition Multimedia Interface are trademarks or registered trademarks of HDMI Licensing LLC in the United States and other countries.

DLP®, DLP Link and the DLP logo are registered trademarks of Texas Instruments and BrilliantColor™ is a trademark of Texas Instruments.

All other product names used in this manual are the properties of their respective owners and are Acknowledged.

FCC

This device has been tested and found to comply with the limits for a Class B digital device pursuant to Part 15 of the FCC rules. These limits are designed to provide reasonable protection against harmful interference in a residential installation. This device generates, uses and can radiate radio frequency energy and, if not installed and used in accordance with the instructions, may cause harmful interference to radio communications.

However, there is no guarantee that interference will not occur in a particular installation. If this device does cause harmful interference to radio or television reception, which can be determined by turning the device off and on is encouraged to try to correct the interference by one or more of the following measures:

- Reorient or relocate the receiving antenna.
- Increase the separation between the device and receiver.
- Connect the device into an outlet on a circuit different from that to which the receiver is connected.
- Consult the dealer or an experienced radio/television technician for help.

Notice: Shielded cables

All connections to other computing devices must be made using shielded cables to maintain compliance with FCC regulations.

Caution

Changes or modifications not expressly approved by the manufacturer could void the user's authority, which is granted by the Federal Communications Commission, to operate this projector.

Operation Conditions

This device complies with Part 15 of the FCC Rules. Operation is subject to the following two conditions:

1. This device may not cause harmful interference and
2. This device must accept any interference received, including interference that may cause undesired operation.

Notice: Canadian users

This Class B digital apparatus complies with Canadian ICES-003.

Remarque à l'intention des utilisateurs canadiens

Cet appareil numérique de la classe B est conforme à la norme NMB-003 du Canada.

Declaration of Conformity for EU countries

- EMC Directive 2014/30/EU (including amendments)
- Low Voltage Directive 2014/35/EU
- RED 2014/53/EU (if product has RF function)

WEEE



Disposal instructions

Do not throw this electronic device into the trash when discarding. To minimize pollution and ensure utmost protection of the global environment, please recycle it.

INTRODUCTION

Thank you for purchasing an Optoma laser projector. For full list of features please visit the product page on our website, where you will also find additional information and documentation such as FAQs.

Package Overview

Carefully unpack and verify that you have the items listed below under standard accessories. Some of the items under optional accessories may not be available depending on the model, specification and your region of purchase. Please check with your place of purchase. Some accessories may vary from region to region.

The warranty card is only supplied in some specific regions. Please consult your dealer for detailed information.

Standard accessories

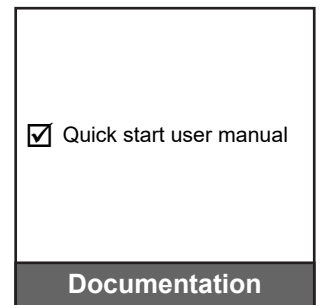
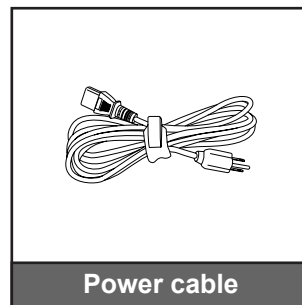
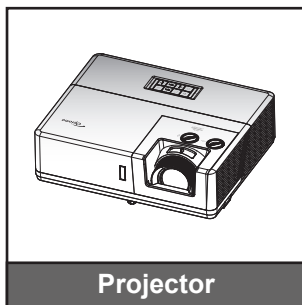

Note:

- For access to the setup information, user manual, warranty information, and product updates – please scan the QR Code or visit the following URL:
<https://www.optoma.com/support/download>



INTRODUCTION

Product Overview

WUXGA 1.6x lens model

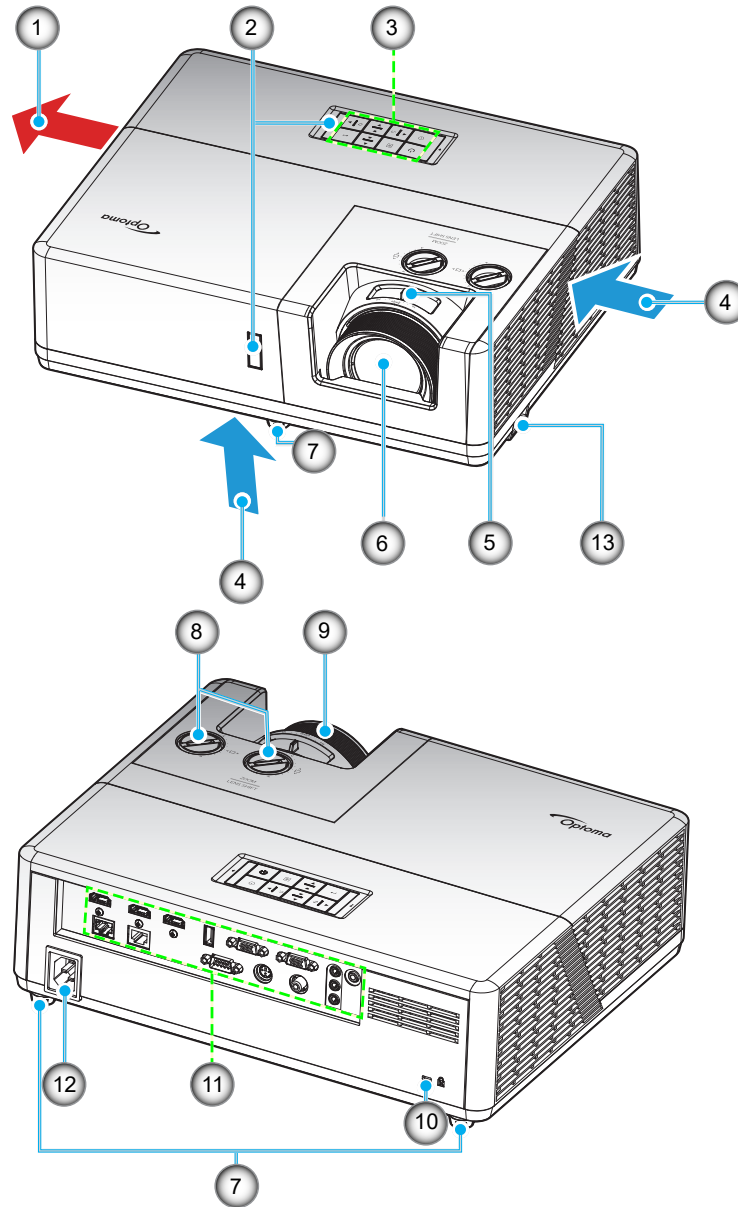

Note:

- Do not block projector intake and exhaust vents.
- When operating the projector in an enclosed space, allow at least 30 cm clearance around the intake and exhaust vents.

No	Item	No	Item
1.	Ventilation (outlet)	8.	Lens Shift Dial
2.	IR Receivers	9.	Focus Ring
3.	Keypad	10.	Kensington™ Lock Port
4.	Ventilation (inlet)	11.	Input / Output
5.	Zoom Lever(*)	12.	AC Jack
6.	Lens	13.	Security Bar
7.	Tilt-Adjustment Feet		

Note: (*)Some fixed zoom models will not support zoom adjust function.

INTRODUCTION

WUXGA Short Throw model

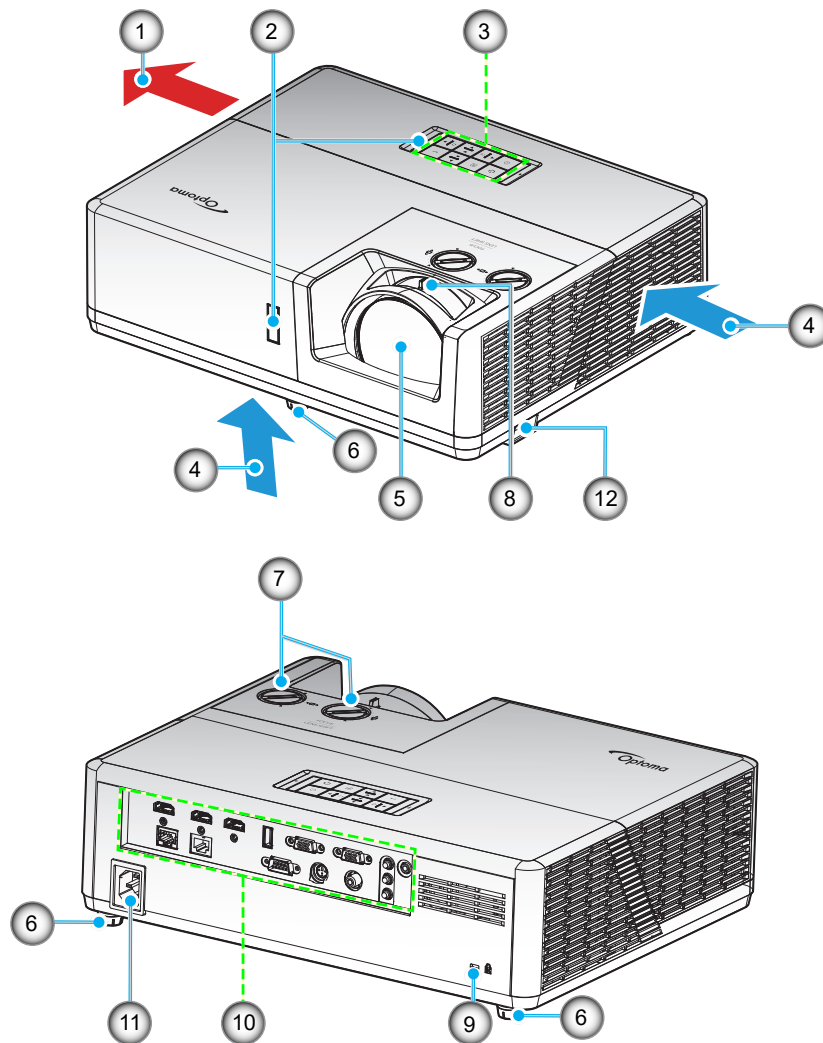

Note:

- Do not block projector intake and exhaust vents.
- When operating the projector in an enclosed space, allow at least 30 cm clearance around the intake and exhaust vents.

No	Item	No	Item
1.	Ventilation (outlet)	7.	Lens Shift Dial
2.	IR Receivers	8.	Focus Lever
3.	Keypad	9.	Kensington™ Lock Port
4.	Ventilation (inlet)	10.	Input / Output
5.	Lens	11.	AC Jack
6.	Tilt-Adjustment Feet	12.	Security Bar

INTRODUCTION

Connections

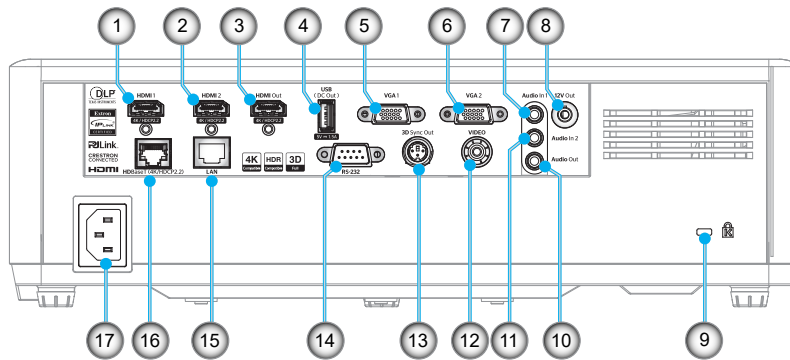

No	Item	No	Item
1.	HDMI 1 Connector	10.	Audio Out Connector
2.	HDMI 2 Connector	11.	Audio In 2 Connector
3.	HDMI Out Connector	12.	Video Connector
4.	USB Power Out (5V---1.5A) Connector	13.	3D Sync Out Connector
5.	VGA 1 Connector	14.	RS232 Connector
6.	VGA 2 Connector	15.	LAN Connector
7.	Audio In 1 Connector	16.	HDBaseT (4K/HDCP2.2) Connector
8.	12V Out Connector	17.	AC Jack
9.	Kensington™ Lock Port		

Note: Signal mode support varies from different model in each sales region.

Keypad

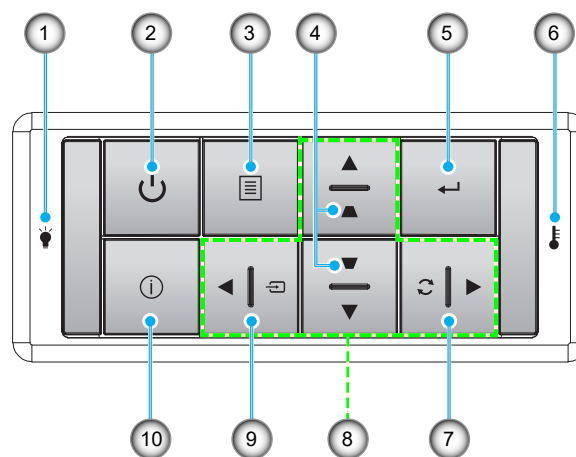

No	Item	No	Item
1.	LD LED	6.	Temp LED
2.	Power and Power LED	7.	Re-Sync
3.	Menu	8.	Four Directional Select Keys
4.	Keystone Correction	9.	Source
5.	Enter	10.	Information

INTRODUCTION

Remote control

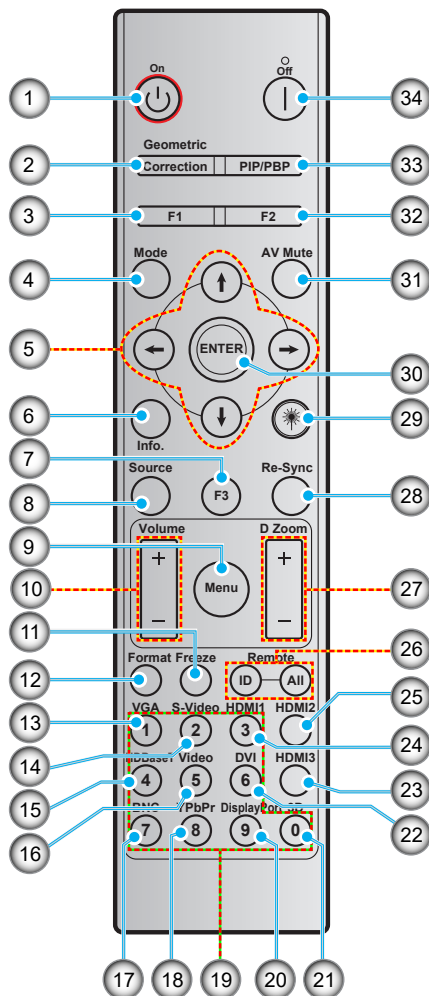

No	Item	No	Item
1.	Power on	18.	YPbPr (not supported)
2.	Geometric Correction	19.	Numeric keypad (0-9)
3.	Function button (F1) (Assignable)	20.	Display port (not supported)
4.	Mode	21.	3D
5.	Four directional select keys	22.	DVI (not supported)
6.	Information	23.	HDMI3 (not supported)
7.	Function button (F3) (Assignable)	24.	HDMI1
8.	Source	25.	HDMI2
9.	Menu	26.	Remote ID / Remote all
10.	Volume - / +	27.	Digital Zoom - / +
11.	Freeze	28.	Re-sync
12.	Format (Aspect Ratio)	29.	Laser pointer
13.	VGA	30.	Enter
14.	S-Video (not supported)	31.	AV Mute
15.	HDBase-T	32.	Function button (F2) (Assignable)
16.	Video	33.	PIP/PBP (not supported)
17.	BNC (not supported)	34.	Power off

Note: Some keys may have no function for models that do not support these features.

SETUP AND INSTALLATION

Installing the projector

Your projector is designed to be installed in one of four possible positions.

Your room layout or personal preference will dictate which installation location you select. Take into consideration the size and position of your screen, the location of a suitable power outlet, as well as the location and distance between the projector and the rest of your equipment.

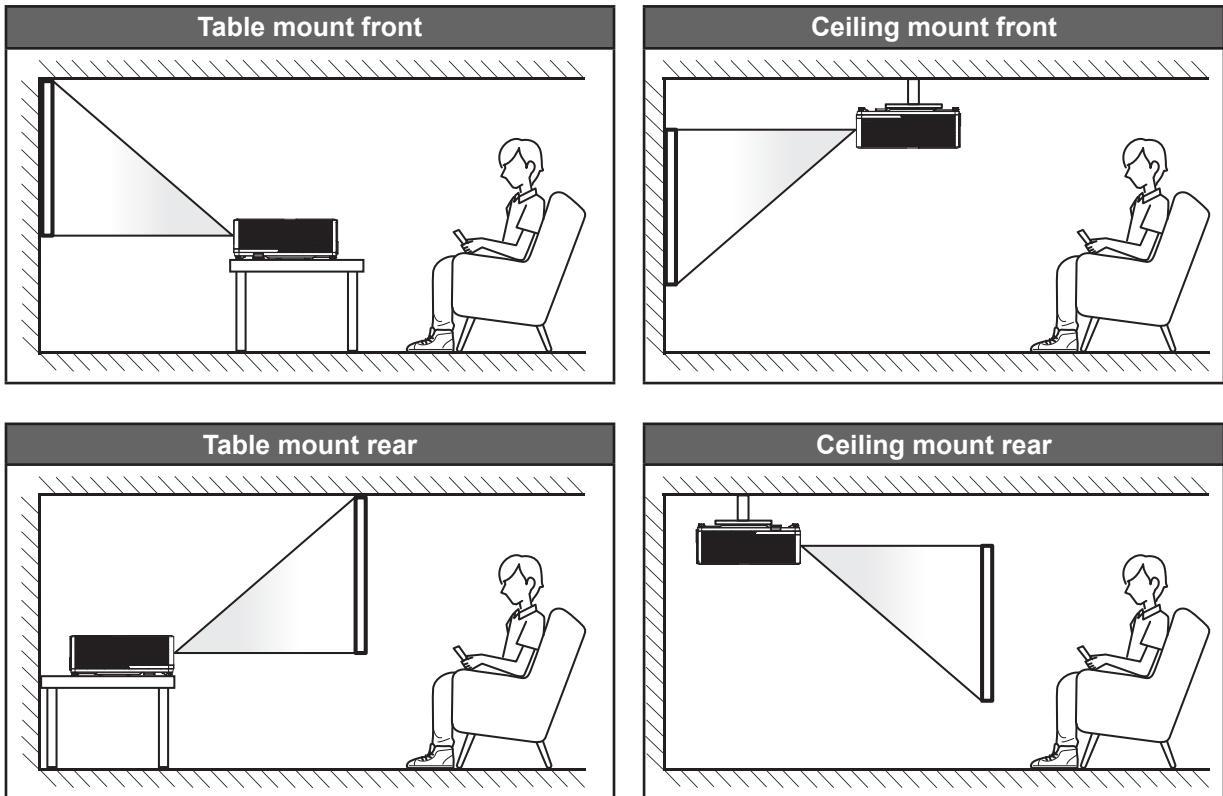

Projector should be placed flat on a surface and 90 degrees / perpendicular to the screen.

- How to determine projector location for a given screen size, please refer to distance table on pages 64~66.
- How to determine screen size for a given distance, please refer to distance table on pages 64~66.

Note: *The further away the projector is placed from the screen the projected image size increases and vertical offset also increases proportionally.*

SETUP AND INSTALLATION

Projector installation notice

- 360° free orientation operation

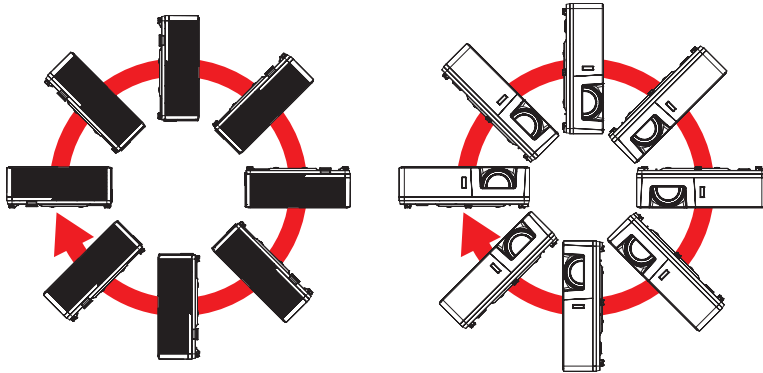

- Allow at least 30 cm clearance around the exhaust vent.

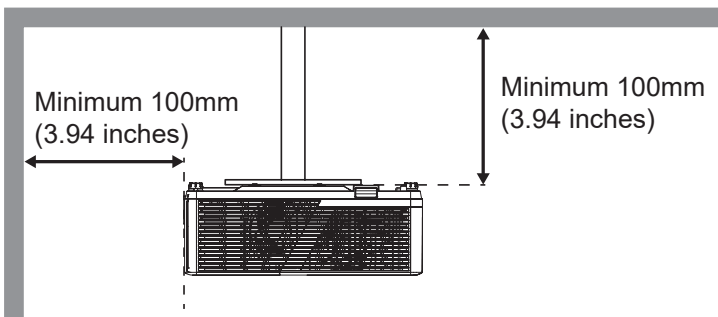
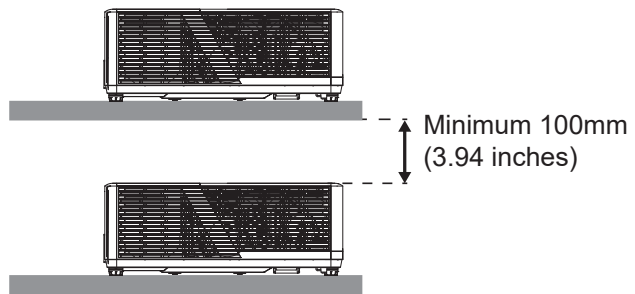
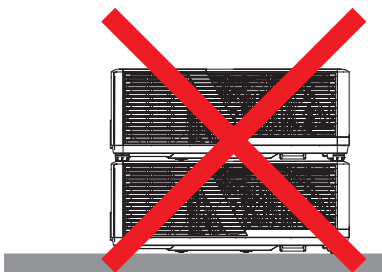
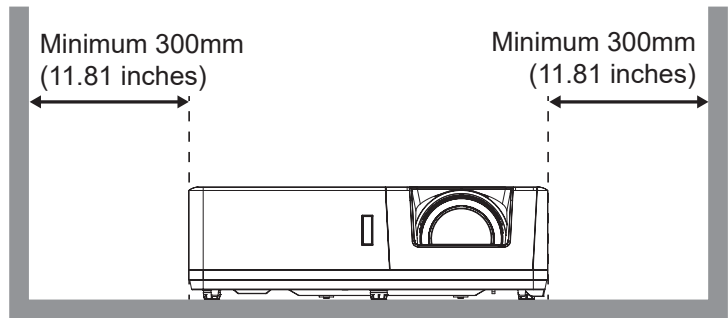
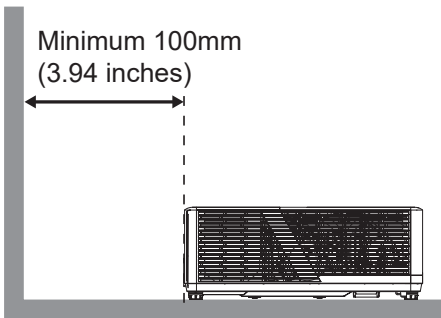

- Ensure that the intake vents do not recycle hot air from the exhaust vent.
- When operating the projector in an enclosed space, ensure that the surrounding air temperature within the enclosure does not exceed operation temperature while the projector is running, and the air intake and exhaust vents are unobstructed.
- All enclosures should pass a certified thermal evaluation to ensure that the projector does not recycle exhaust air, as this may cause the device to shutdown even if the enclosure temperature is within the acceptable operation temperature range.

SETUP AND INSTALLATION

Connecting sources to the projector

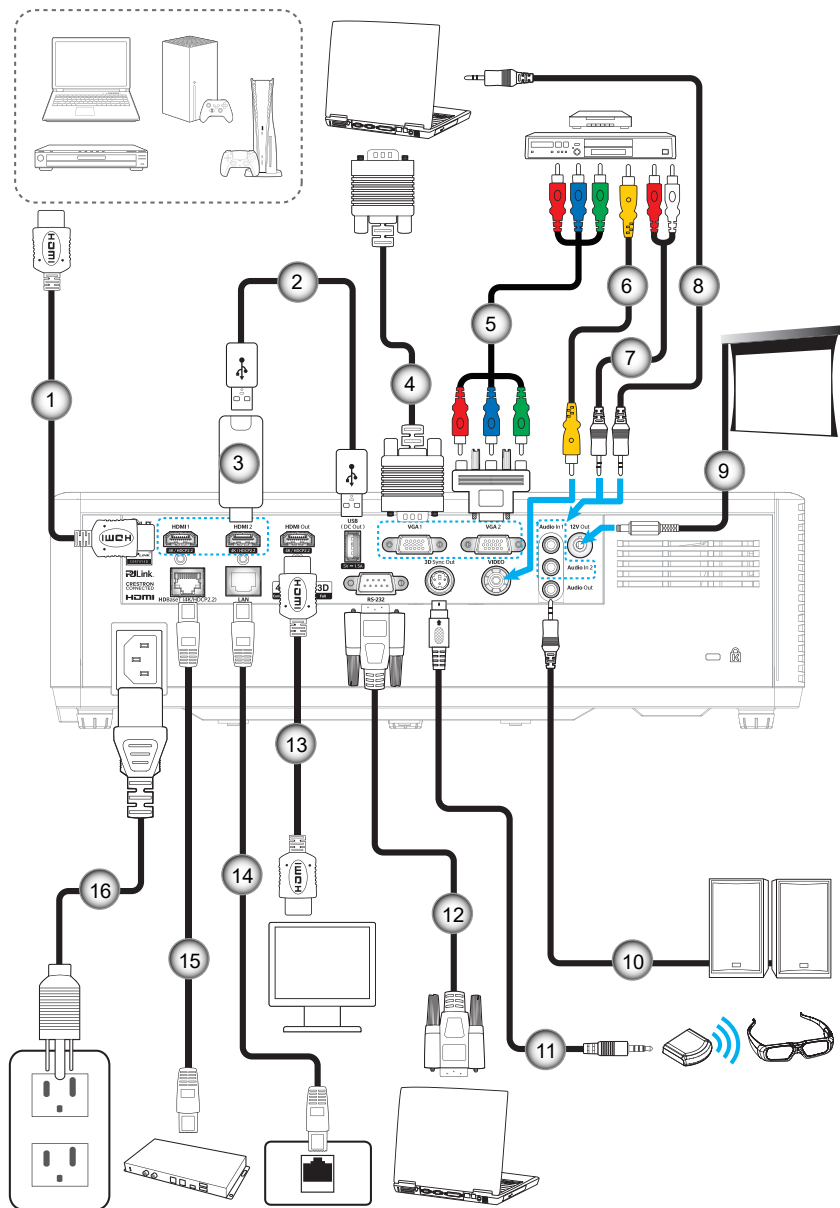

No	Item	No	Item
1.	HDMI Cable	9.	12V DC Jack
2.	USB Power Cable	10.	Speaker Cable
3.	HDMI Dongle	11.	3D Emitter Cable
4.	VGA Cable	12.	RS232 Cable
5.	RCA Component Cable	13.	HDMI Cable
6.	Video Cable	14.	RJ-45 Cable
7.	Audio In Cable	15.	RJ-45 Cable
8.	Audio In Cable	16.	Power Cord

Note: To ensure the best image quality and avoid connection errors, we recommend the use of High Speed or Premium Certified HDMI cables up to 5 meters.

SETUP AND INSTALLATION

Adjusting the projector image

Image height

The projector is equipped with elevator feet for adjusting the image height.

1. Locate the adjustable foot you wish to adjust on the underside of the projector.
2. Rotate the adjustable foot clockwise or counterclockwise to raise or lower the projector.

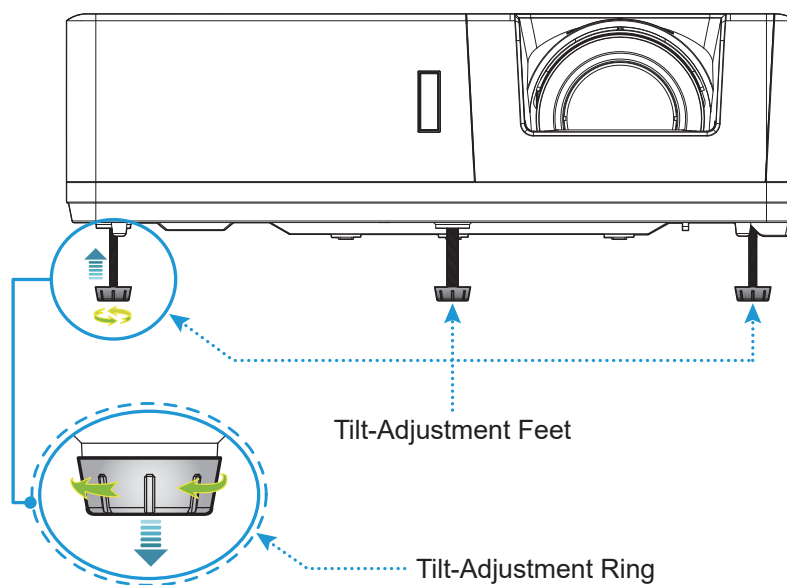

SETUP AND INSTALLATION

Zoom, focus, and lens shift

WUXGA 1.6x lens model

- To adjust the image size, turn the zoom lever clockwise or counterclockwise to increase or decrease the projected image size.
Note: Some fixed zoom models will not support zoom adjust function.
- To adjust the focus, turn the focus ring clockwise or counterclockwise until the image is sharp and legible.

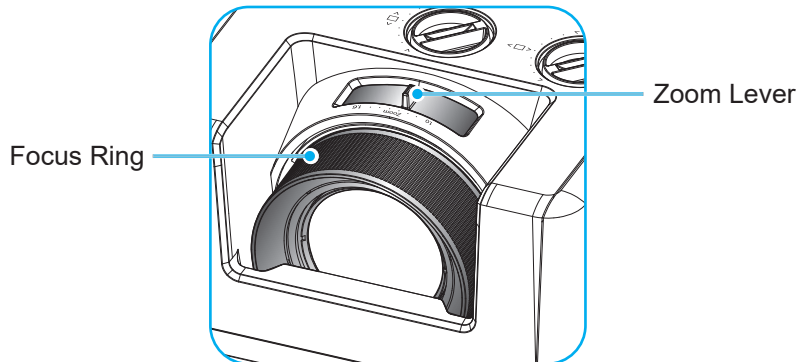

- To adjust the image position, turn the lens shift dial clockwise or counterclockwise to adjust the position of the projected image vertically or horizontally.

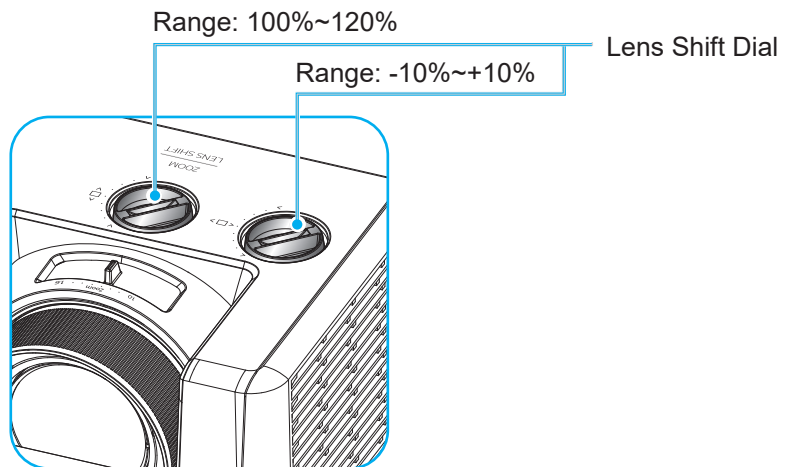

SETUP AND INSTALLATION

WUXGA Short Throw model

- To adjust the focus, turn the focus ring clockwise or counterclockwise until the image is sharp and legible.

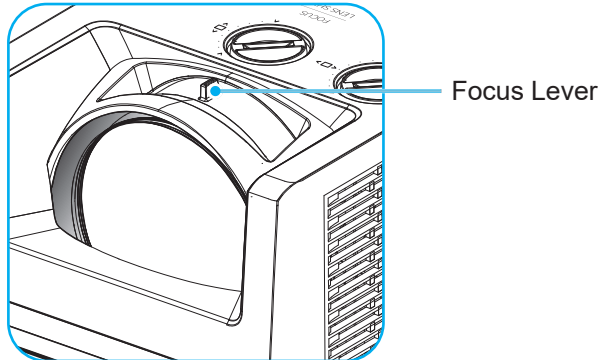

- To adjust the image position, turn the lens shift dial clockwise or counterclockwise to adjust the position of the projected image vertically or horizontally.

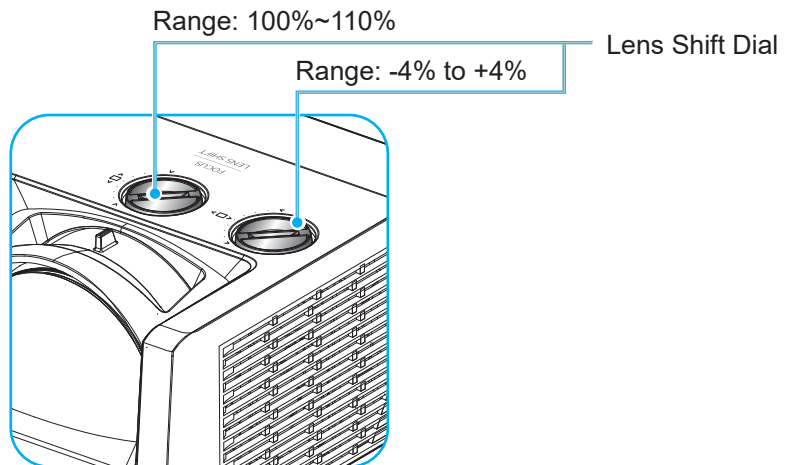

SETUP AND INSTALLATION

Remote setup

Installing / replacing the batteries

Two AAA size batteries are supplied for the remote control.

1. Remove the battery cover on the back of the remote control.
2. Insert AAA batteries in the battery compartment as illustrated.
3. Replace back cover on remote control.

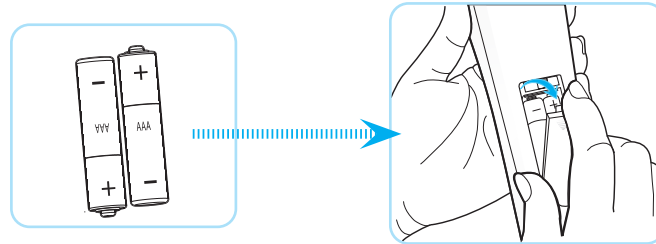

Note: Replace only with the same or equivalent type batteries.

CAUTION: To ensure safe operation, please observe the following precautions:

- Replacement of a battery with an incorrect type that can defeat a safeguard (AAA size battery type).
- Disposal of a battery into a fire, hot oven, mechanically crushing or cutting of a battery, may result in an explosion.
- Leaving a battery in an extremely high temperature surrounding environment that can result in an explosion or the leakage of flammable liquid or gas.
- A battery subjected to extremely low air pressure that may result in an explosion or the leakage of flammable liquid or gas.
- Do not mix old and new batteries. Mixing old and new batteries can shorten the life of new batteries or cause a chemical leak in the old batteries.
- Remove batteries as soon as they are depleted. Chemicals that leak from a battery which comes into contact with your skin can cause a rash. If you find any chemical leakage, wipe thoroughly with a cloth.
- The batteries supplied with this product may have a shorter life expectancy due to storage conditions.
- If you are not using the remote control for an extended period of time, please remove the batteries to reduce risk of chemical leak.

SETUP AND INSTALLATION

Effective range

Infra-Red (IR) remote control sensor is located on the top and front sides of the projector. Ensure to hold the remote control at an angle within 30 degrees perpendicular to the projector's IR remote control sensor to function correctly. The distance between the remote control and the sensor should not be longer than 6 meters (19.7 feet) when holding in an angle $\pm 15^\circ$ and not longer than 8 meters (26.2 feet) when aiming the sensor at 0° .

- Make sure that there are no obstacles between the remote control and the IR sensor on the projector that might obstruct the infra-red beam.
- Make sure the IR transmitter of the remote control is not being shined by sunlight or fluorescent lamps directly.
- Please keep the remote controller away from fluorescent lamps for over 2 m or the remote controller might become malfunction.
- If the remote control is close to Inverter-Type fluorescent lamps, it might become ineffective from time to time.
- If the remote control and the projector are within a very short distance, the remote control might become ineffective.
- When you aim at the screen, the effective distance is less than 5 m from the remote control to the screen and reflecting the IR beams back to the projector. However, the effective range might change according to screens.

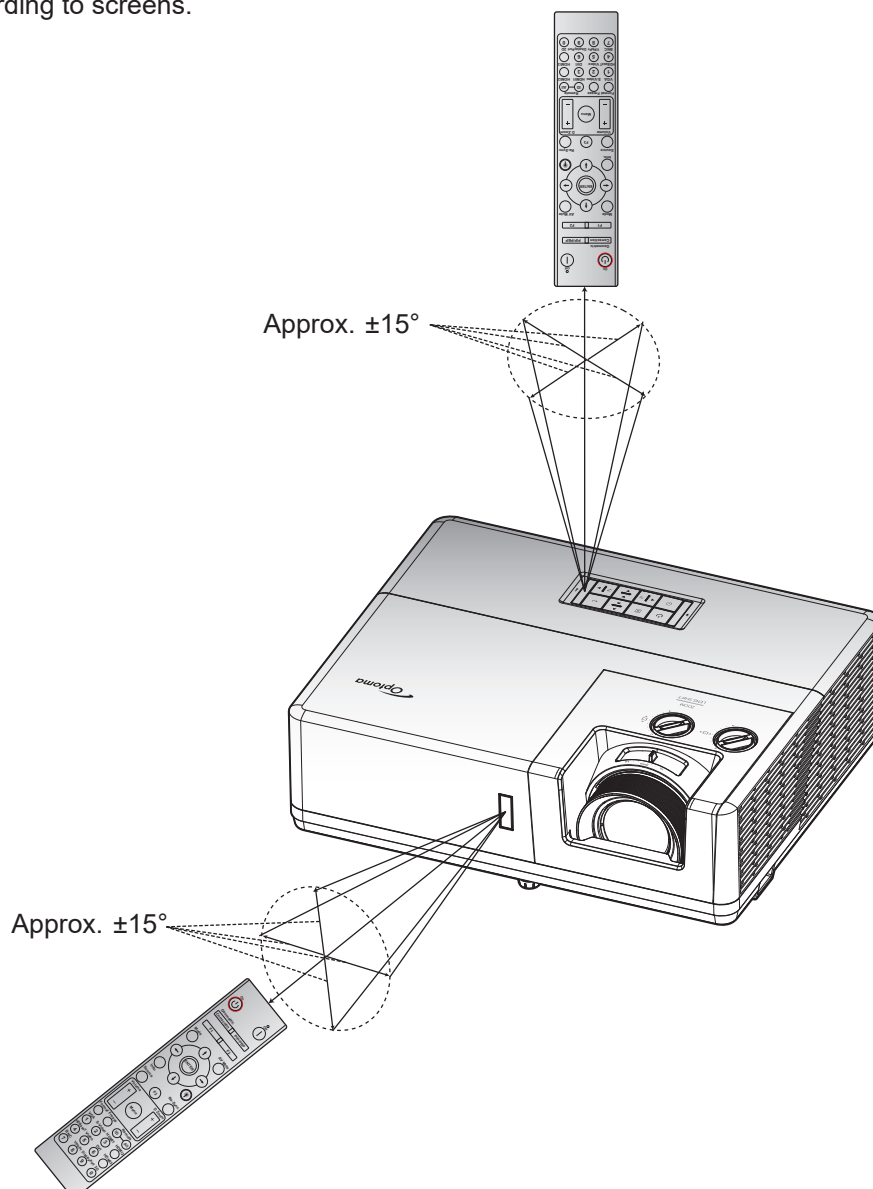

USING THE PROJECTOR

Powering on / off the projector

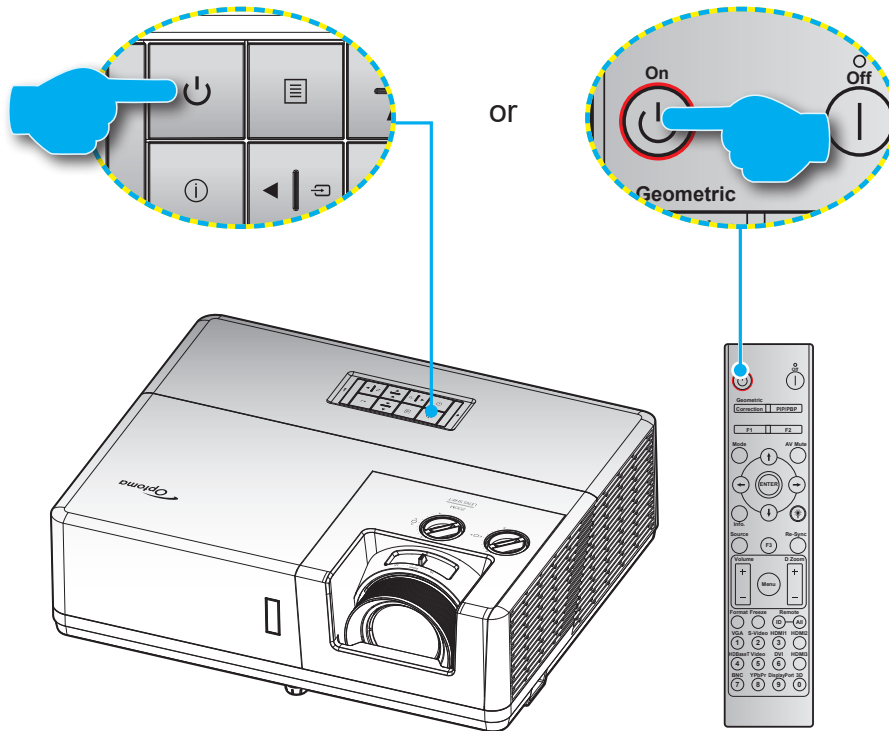

Powering on



1. Securely connect the power lead and signal/source cable. When connected, the Power LED will turn red.
2. Turn on the projector by pressing the  button on the projector keypad or the remote control.
3. A start up screen will display in approximately 10 seconds and the Power LED will be flashing white.

Note: The first time the projector is turned on, you will be prompted to select the preferred language, projection orientation, and other settings.

Powering off

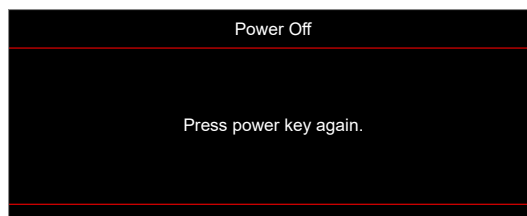
1. Turn off the projector by pressing the  button on the projector keypad or the remote control.
2. The following message will be displayed:



3. Press the  button again to confirm, otherwise the message will disappear after 15 seconds. When you press the  button for the second time, the projector will shut down.
4. The cooling fans will continue to operate for about 10 seconds for the cooling cycle and the Power LED will flash white. When the Power LED turns solid red, this indicates the projector has entered standby mode. If you wish to turn the projector back on, you must wait until the cooling cycle has finished and the projector has entered standby mode. When the projector is in standby mode, simply press the  button again to turn on the projector.
5. Disconnect the power lead from the electrical outlet and the projector.

Note: It is not recommended that the projector is turned on immediately, right after a power off procedure.

USING THE PROJECTOR

Selecting an input source

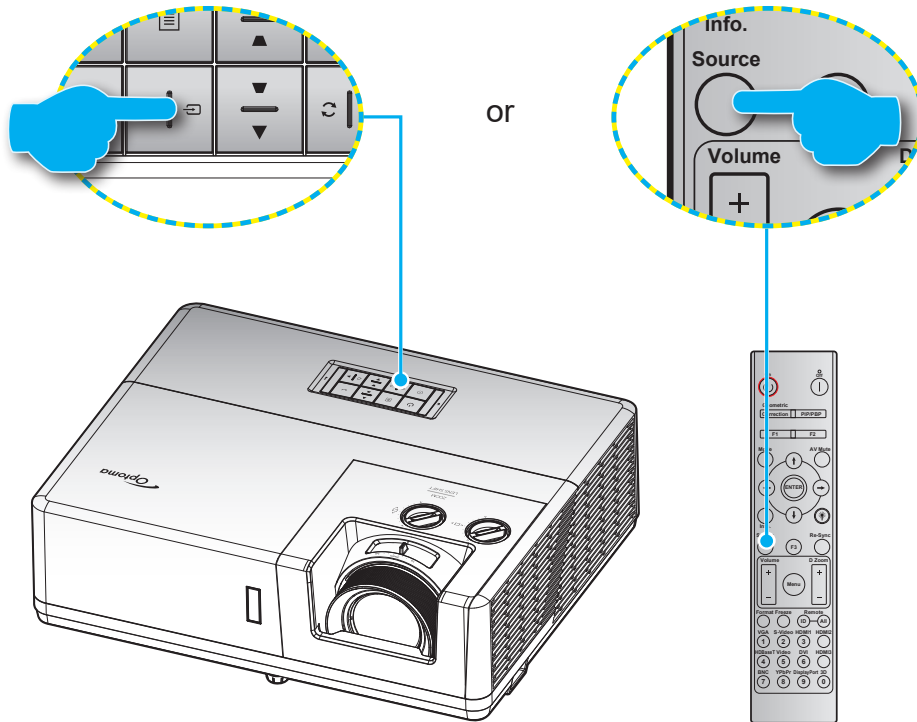

Turn on the connected source that you want to display on the screen, such as computer, notebook, video player, etc. The projector will automatically detect the source. If multiple sources are connected, press the  button on the projector keypad or the **Source** button remote control to select the desired input.



USING THE PROJECTOR

Menu navigation and features

The projector has multilingual on-screen display menus that allow you to make image adjustments and change a variety of settings. The projector will automatically detect the source.

1. To open the OSD menu, press the  button on the projector keypad or the **Menu** button on the remote control.
2. When OSD is displayed, use **▲▼** keys to select any item in the main menu. While making a selection on a particular page, press the **←** button on the projector keypad or the **Enter** button on the remote control to enter sub menu.
3. Use **◀▶** keys to select the desired item in the sub menu and then press the **←** or **Enter** button to view further settings. Adjust the settings by using **◀▶** keys.
4. Select the next item to be adjusted in the sub menu and adjust as described above.
5. Press press the **←** or **Enter** button to confirm, and the screen will return to the main menu.
6. To exit, press the  or **Menu** button again. The OSD menu will close and the projector will automatically save the new settings.

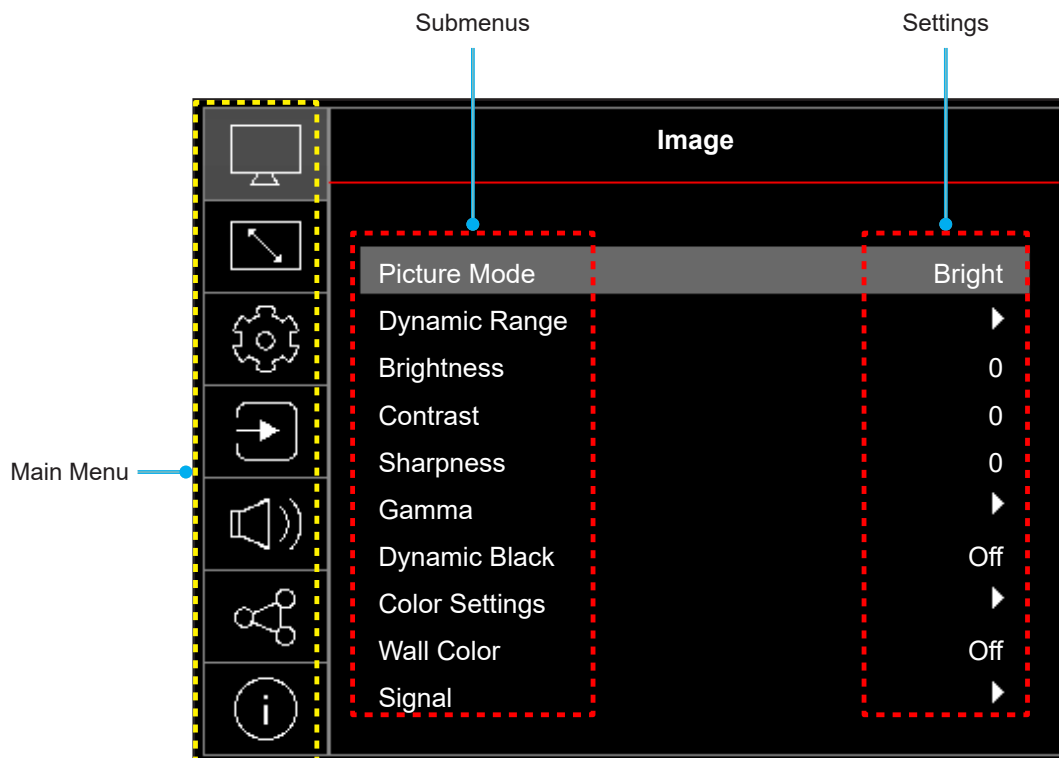

USING THE PROJECTOR

OSD Menu tree

Note: The OSD menu tree items and features are subject to models and region. Optoma reserve the right to add or remove items to improve product performance without notice.

Main Menu	Sub Menu	Sub Menu 2	Sub Menu 3	Sub Menu 4	Values		
Image	Picture Mode				Vivid		
					HDR [for HDMI 2.0 models]		
					HLG [for HDMI 2.0 models]		
					Cinema		
					Game		
					Reference		
					Bright		
					DICOM SIM.		
	Dynamic Range [for HDMI 2.0 models]	HDR / HLG				Auto	
						Off	
		HDR / HLG Picture Mode				Bright	
						Standard	
						Film	
						Detail	
	Brightness				-50 ~ 50		
	Contrast				-50 ~ 50		
	Sharpness				1 ~ 15		
	Gamma					Film	
						Graphics	
						1.8	
						2.0	
						2.2	
	Dynamic Black					2.4	
						Off	
	Color Settings					On	
		Color	Color			-50 ~ 50	
			Tint			-50 ~ 50	
			BrilliantColor™			1 ~ 10	
		Color Temperature				Warm	
						Standard	
						Cool	
		CMS					Cold
			Color	Color			White / Red / Green / Blue / Cyan / Magenta / Yellow
				Hue			-50 ~ 50
				Saturation			-50 ~ 50
	Luminance					-50 ~ 50	
Reset				No			
				Yes			

USING THE PROJECTOR

Main Menu	Sub Menu	Sub Menu 2	Sub Menu 3	Sub Menu 4	Values
Image	Color Settings	Color Space			HDMI Input: Auto / RGB(0~255) / RGB(16~235) / YUV
					Non-HDMI Input: Auto / RGB / YUV
		IRE			0
					7.5
	Wall Color				Off
					Blackboard
					Light Yellow
					Light Green
					Light Blue
					Pink
					Grey
	Signal	Automatic			Off
					On
		Frequency			-50 ~ 50 (depends on signal)
		Phase			0 ~ 31 (depends on signal)
		H Position			-50 ~ 50 (depends on signal)
	V Position			-50 ~ 50 (depends on signal)	
	3D	3D Mode			Off
					On
		3D Sync Type			DLP-Link
					3D Sync
		3D-2D Conversion			3D
					L
		3D Format			R
					Auto
					SBS
					Top and Bottom
3D Sync Invert				Frame Sequential	
				Frame Packing	
				Off	
Reset			On		
			No		
			Yes		
Display	Light Source Mode			Eco.	
				Power =100% / 95% / 90% / 85% / 80% / 75% / 70% / 65% / 60% / 55% / 50%	
	Gaming Mode			Off	
				On	
	Screen Type			4:3	
				16:9	
			16:10		

USING THE PROJECTOR

Main Menu	Sub Menu	Sub Menu 2	Sub Menu 3	Sub Menu 4	Values	
Display	Aspect Ratio				4:3 [Screen Type: 4:3]	
					16:9 [Screen Type: 16:9]	
					16:10 [Screen Type: 16:10]	
					21:9	
					32:9	
					LBX	
					Native	
					Auto	
	Geometric Correction	Auto Keystone				Off
						On
		V Keystone				-30 ~ 30
		H Keystone				-30 ~ 30
		Four Corner Adjustment				
	Reset					
Edge Mask					0 ~ 10	
Digital Zoom	Zoom				-20 ~ 50	
Image Shift	H 				-100 ~ 100	
	V 				-100 ~ 100	
Reset						
Setup	Test Pattern				Green Grid	
					Magenta Grid	
					White Grid	
					White	
					Off	
	Projection Orientation					Front
						Rear
						Ceiling-Top
						Rear-Top
	Language					English
						Deutsch
						Français
						Italiano
						Español
						Português
						Polski
						Nederlands
						Svenska
						Norsk
				Dansk		
				Suomi		
				ελληνικά		
				繁體中文		
				簡體中文		

USING THE PROJECTOR

Main Menu	Sub Menu	Sub Menu 2	Sub Menu 3	Sub Menu 4	Values		
Setup	Language				日本語		
					한국어		
					Русский		
					Magyar		
					Čeština		
					عربي		
					ไทย		
					Türkçe		
					فارسی		
					Tiếng Việt		
					Bahasa Indonesia		
				Română			
	Menu Settings	Menu Location				Top Left 	
						Top Right 	
						Center 	
						Bottom Left 	
						Bottom Right 	
		Menu Timer					Off
							5s
							10s
							20s
							30s
		Information Hide					Off
							On
		High Altitude					Off
							On
		Filter Settings	Filter Usage Hours				(read only)
	Optional Filter Installed					No	
						Yes	
	Filter Reminder						Off
							300hr
							500hr
							800hr
	Filter Reset						1000hr
						No	
	Power Settings	Direct Power On				Off	
						On	
		Signal Power On					Off
							On
		Auto Power Off (min.)				0, 2 ~ 180 (1 min increments)	
	Sleep Timer (min.)				0 ~ 990 (30 min increments)		

USING THE PROJECTOR

Main Menu	Sub Menu	Sub Menu 2	Sub Menu 3	Sub Menu 4	Values
Setup	Power Settings	Power Mode (Standby)			Active
					Eco
		USB Power			Off
					On
		12V Trigger			Off
					On
	Security	Security			Off
					On
		Security Timer	Month		
			Day		
			Hour		
	Change Password				
	Keypad Settings	Keypad Lock			Off
					On
	Startup Logo				Default
					Neutral
					Custom
	Background Color				None
					Blue
					Red
					Green
					Grey
					Logo
	Closed Captioning				CC1
					CC2
					Off
	Device Reset	Reset OSD			No
				Yes	
Reset All Settings				No	
				Yes	
Input	Auto Source			Off	
				On	
	Rename Input Source	HDMI 1 / HDMI 2 / VGA 1 / VGA 2 / Video / HDBaseT			Default
					Custom
	Input Hide	HDMI 1 / HDMI 2 / VGA 1 / VGA 2 / Video / HDBaseT			No
					Yes
	EDID Settings	HDMI 1 EDID / HDMI 2 EDID / HDBaseT EDID			1.4
					2.0
	HDMI Out				HDMI 1
					HDMI 2
	HDMI CEC Settings	HDMI Link			Off
				On	
Inclusive of TV					No
				Yes	

USING THE PROJECTOR

Main Menu	Sub Menu	Sub Menu 2	Sub Menu 3	Sub Menu 4	Values	
Input	HDMI CEC Settings	Power On Link			Mutual	
					PJ → Device	
		Power Off Link			Device → PJ	
					Off	
	Reset				On	
					No	
Audio	Volume				0 ~ 100	
	Mute				Off	
					On	
	Audio Output				Internal Speaker	
					Line Out	
	Audio Input	HDMI 1 / HDMI 2 / HDBaseT				Audio 1
						Audio 2
		VGA 1 / VGA 2 / Video				Default
					Audio 1	
Reset				Audio 2		
Control	Device ID				0 ~ 99	
	Remote Settings	IR Function			On	
					Front	
					Top	
					Off	
		Remote Code				0 ~ 99
		F1/ F2/ F3				HDMI 1/HDMI 2/Test Pattern/ Brightness/Contrast/Sleep Timer/ CMS/Color Temperature/Gamma/ Projection/Light Source Mode/ Zoom/Freeze/ (Depends on model)
	LAN	Network Status				(read only; Connected / Disconnected)
		MAC Address				(read only)
		DHCP				Off / On
		IP Address				192.168.0.100
		Subnet Mask				255.255.255.0
		Gateway				192.168.0.254
		DNS				192.168.0.51; 0.0.0.0
		Reset				
	Control	Crestron (Port 41794)				Off
						On
		Extron (Port 2023)				Off
						On
		PJ Link (Port 4352)				Off
AMX Device Discovery (Port 9131)					On	
					Off	

USING THE PROJECTOR

Main Menu	Sub Menu	Sub Menu 2	Sub Menu 3	Sub Menu 4	Values
Control	Control	Telnet (Port 23)			Off
					On
		HTTP (Port 80)			Off
					On
	HDBaseT Control	Ethernet			Off
					On
		RS232			Off
					On
Reset					
Information	Regulatory				
	Serial Number				
	Source Info.				Source
					Resolution(00x00)
					Refresh Rate(0.00Hz)
	Picture Mode				
	Color Info.				Color Bit Depth
					Color Gamut
					Color Space
	Power Mode (Standby)				Active/Eco
	Light Source Hours				
	Light Source Mode				
	Remote Code				00 ~ 99
	Remote Code (Active)				00 ~ 99
	Device ID				00 ~ 99
	IP Address				
	Network Status				
FW Version	DDP				
	MCU				
	LAN				
	HDBT				

USING THE PROJECTOR

Image menu

Learn how to configure image settings.

Submenus

- Picture Mode
- Dynamic Range
- Brightness
- Contrast
- Sharpness
- Gamma
- Dynamic Black
- Color Settings
- Wall Color
- Signal
- 3D

Picture Mode

There are several predefined display modes that you can choose from to suit your viewing preference. Each mode has been fine-tuned by our expert colour team to ensure superior colour performance for wide range of content.

- **Vivid:** In this mode, the color saturation and brightness are well-balanced. Choose this mode for playing games.
- **HDR / HLG:** Decodes and displays High Dynamic Range (HDR) / Hybrid Log Gamma (HLG) content for the deepest blacks, brightest whites, and vivid cinematic color using REC.2020 color gamut. This mode will be automatically enabled if HDR/HLG is set to Auto (and HDR/HLG Content is sent to projector – 4K UHD Blu-ray, 1080p/4K UHD HDR/HLG Games, 4K UHD Streaming Video). While HDR/HLG mode is active, other display modes (Cinema, Reference, etc.) cannot be selected as HDR/HLG delivers color that is highly accurate, exceeding the color performance of the other display modes.
- **Cinema:** Provides the best balance of detail and colors for watching movies.
- **Game:** Optimises your projector for maximum contrast and vivid colours allowing you to see shadow detail when playing video games.
- **Reference:** This mode reproduces colours as close as possible the image the way the movie director intended. Color, color temperature, brightness, contrast and gamma settings are all configured to Rec.709 color gamut. Select this mode for the most accurate colour reproduction when watching movies.
- **Bright:** This mode is suitable for environments where extra-high brightness is required, such as using the projector in well-lit rooms.
- **DICOM SIM.:** This mode has been created for viewing greyscale images, perfect for viewing X-rays and scans during medical training*.
Note: **This projector is not suitable for use in medical diagnosis.*
- **3D:** Optimized settings for watching 3D content.
Note: *To experience the 3D effect, you will need to have compatible DLP Link 3D glasses. See 3D section for more information.*

USING THE PROJECTOR

Dynamic Range

HDR / HLG

Configure the High Dynamic Range (HDR) / Hybrid Log Gamma(HLG) setting and its effect when displaying video from 4K Blu-ray players and streaming devices.

- **Auto:** Auto detect HDR/HLG signal.
- **Off:** Turn off HDR/HLG Processing. When set to Off, the projector will NOT decode HDR/HLG content.

HDR / HLG Picture Mode

- **Bright:** Choose this mode for brighter more saturated colors.
- **Standard:** Choose this mode for natural looking colors with a balance of warm and cool tones.
- **Film:** Choose this mode for improved detail and image sharpness.
- **Detail:** The signal comes from OETF conversion to achieve the best color matching.

Brightness

Adjust the brightness of the image.

Contrast

The contrast controls the degree of difference between the lightest and darkest parts of the picture.

Sharpness

Adjust the sharpness of the image.

Gamma

Set up gamma curve type. After the initial setup and fine tuning is completed, utilize the Gamma Adjustment steps to optimize your image output.

- **Film:** For home theater.
- **Graphics:** For PC / Photo source.
- **1.8 / 2.0 / 2.2 / 2.4:** For specific PC / Photo source.

Dynamic Black

Use to automatically adjust the picture brightness in order to give optimum contrast performance.

Color Settings

Color

Adjust a video image from black and white to fully saturated color.

Tint

Adjust the color balance of red and green.

BrilliantColor™

This adjustable item utilizes a new color-processing algorithm and enhancements to enable higher brightness while providing true, more vibrant colors in picture.

Color Temperature

Select a color temperature from Warm, Standard, Cool, or Cold.

USING THE PROJECTOR

CMS

Select the following options:

- **Color:** Adjust the red, green, blue, cyan, yellow, magenta, and white level of the image.
- **Hue:** Adjust the color balance of red and green.
- **Saturation:** Adjust a video image from black and white to fully saturated color.
- **Luminance:** Adjust the luminance of the selected color.
- **Reset:** Return the factory default settings for color adjustment.

Color Space

Select an appropriate color matrix type:

- **Color Space** (non-HDMI input only): Select an appropriate color matrix type from the following: Auto, RGB, or YUV.
- **Color Space** (HDMI input only): select an appropriate color matrix type from the following: Auto, RGB(0-255), RGB(16-235), or YUV.

IRE

Allow user to adjust IRE value when inputting Video signals.

Note:

- *IRE is only available with NTSC video format.*
- *IRE can only be adjusted for Video input sources.*

Wall Color

Designed to adjust the colors of the projected image when projecting on to a wall without a screen. Each mode has been fine-tuned by our expert colour team to ensure superior color performance.

There are several predefined modes that you can choose from to suit the colour of your wall. Select between off, blackboard, light yellow, light green, light blue, pink, and grey.

Note: *For accurate color reproduction, we recommend using a screen.*

Signal

Adjust the signal options.

- **Automatic:** Configure automatically the signal (the frequency and phase items are grayed out). If automatic is disabled, the frequency and phase items will appear for tuning and saving the settings.
- **Frequency:** Change the display data frequency to match the frequency of your computer's graphic card. Use this function only if the image appears to flicker vertically.
- **Phase:** Synchronize the signal timing of the display with the graphic card. If the image appears to be unstable or flickers, use this function to correct it.
- **H Position:** Adjust the horizontal positioning of the image.
- **V Position:** Adjust the vertical positioning of the image.

Note: *This menu is only available if the input source is RGB/Component.*

USING THE PROJECTOR

3D

Note:

- *This projector is a 3D ready projector with DLP-Link 3D solution.*
- *Please ensure that 3D glasses are in use for DLP-Link 3D content before enjoying your video.*
- *This projector supports frame sequential (page-flip) 3D via HDMI1/HDMI2 ports.*
- *To enable 3D mode, the input frame rate should be set to 60Hz only, lower or higher frame rate is not supported.*
- *To reach the best performance, resolution 1920x1080 is recommended, please note that 4K (3840x2160) resolution is not supported in 3D mode.*

3D Mode

Use this option to disable or enable the 3D function.

- **Off:** Select “Off” to turn off 3D mode.
- **On:** Select “On” to turn on 3D mode.

3D Sync Type

Use this option to select 3D technology.

- **DLP-Link:** Select to use optimized settings for DLP 3D Glasses.
- **3D Sync:** Select to use optimized settings for IR, RF or polarized 3D Glasses.

3D-2D Conversion

Use this option to specify how the 3D content should appear on the screen.

- **3D:** Display 3D signal.
- **L:** Display the left frame of 3D content.
- **R:** Display the right frame of 3D content.

3D Format

Use this option to select the appropriate 3D format content.

- **Auto:** When a 3D identification signal is detected, the 3D format is selected automatically.
- **Side by Side:** Display 3D signal in “Side-by-Side” format.
- **Top and Bottom:** Display 3D signal in “Top and Bottom” format.
- **Frame Sequential:** Display 3D signal in “Frame Sequential” format.
- **Frame Packing:** Display 3D signal in “Frame Packing” format.

3D Sync Invert

Use this option to enable/disable the 3D sync invert function.

Reset

Return the factory default setting for 3D settings.

- **No:** Select to cancel Reset.
- **Yes:** Select to return the factory default settings for 3D.

Reset

Return the factory default settings for image settings.

USING THE PROJECTOR

Display menu

Learn how to configure the settings to properly project images according to your installation circumstances.

Submenus

- Light Source Mode
- Gaming Mode
- Screen Type
- Aspect Ratio
- Geometric Correction
- Edge Mask
- Digital Zoom
- Image Shift

Light Source Mode

Select a light source mode depending on the installation requirements.

Gaming Mode

Enable this feature to reduce response times (input latency) during gaming to 8.2ms (1080p120 Hz).

All geometry settings (example: Keystone, Four Corners) will be disabled when Gaming Mode is enabled. For more information is below.

Note:

- *The input lag by signals is described in the following table:*
- *The values in the table can vary slightly.*

Source Timing	Gaming Mode	Output Timing	Output Resolution	Input Lag
1080p60 Hz	On	1080p60 Hz	1080p	16.2ms
1080p120 Hz	On	1080p120 Hz	1080p	8.2ms
4K60 Hz	On	1080p60 Hz	1080p	16.2ms
1080p60 Hz	Off	1080p60 Hz	1080p	49.5ms
1080p120 Hz	Off	1080p120 Hz	1080p	24.9ms
4K60 Hz	Off	1080p60 Hz	1080p	49.5ms

Screen Type

Choose the screen type from 4:3, 16:9, and 16:10.

Aspect Ratio

Select the aspect ratio of the displayed image between the following options:

- **4:3:** This format is for 4:3 input sources.
- **16:9:** This format is for 16:9 input sources, like HDTV and DVD enhanced for Wide screen TV.
- **16:10:** This format is for 16:10 input sources.
- **21:9:** This format is for 21:9 input source, like HDTV and DVD enhanced for Wide screen TV.
- **32:9:** This format is for 32:9 input source, like HDTV and DVD enhanced for Wide screen TV.
- **LBX:** This format is for non-16x9, letterbox source and if you use external 16x9 lens to display 2.35:1 aspect ratio in full resolution.
- **Native:** This format displays the original image without any scaling.
- **Auto:** Automatically selects the appropriate display format.

USING THE PROJECTOR

Note:

- Detailed informations about V-Stretch mode:
 - Some Letter-Box Format DVDs are not enhanced for 16x9 TVs. In this situation, the image will not look right when displaying image in 16:9 mode. In this situation, please try to use the 4:3 mode to view the DVD. If the content is not 4:3, there will be black bars around the image in 16:9 display. For this type of content, you can use V-Stretch mode to fill the image on the 16:9 display
 - If you use an external anamorphic lens, this V-Stretch mode also allows you to watch a 2.35:1 content (include Anamorphic DVD and HDTV film source) that supports anamorphic wide is enhanced for 16x9 Display in a wide 2.35:1 image. In this case, there are no black bars. Light source power and vertical resolution are fully utilized
- To use the Full Screen format, do the following:
 - a) Set the screen aspect ratio to 2.0:1.
 - b) Select “Full Screen” format.
 - c) Align the projector image correctly on the screen.

1080p scaling table:

16:9 screen	PC	480i/p	576i/p	720p	1080i/p
4x3	Scale to 1440x1080.				
16x9	Scale to 1920x1080.				
LBX	Scale to 1920x1440, then get the central 1920x1080 image to display.				
Native mode	- 1:1 mapping centered. - No scaling will be made; the image is displayed with the resolution based on input source.				
Auto	- If auto format is selected, the screen type will automatically become 16:9 (1920x1080). - If source is 4:3, the screen type will be scaled to 1440x1080. - If source is 16:9, the screen type will be scaled to 1920x1080. - If source is 16:10, the screen type will be scaled to 1920x1200 and cut 1920x1080 area to display.				

1080p auto mapping rule:

Auto	Input resolution		Auto/Scale	
	H-resolution	V-resolution	1920	1080
4:3	640	480	1440	1080
	800	600	1440	1080
	1024	768	1440	1080
	1280	1024	1440	1080
	1400	1050	1440	1080
	1600	1200	1440	1080
Wide Laptop	1280	720	1920	1080
	1280	768	1800	1080
	1280	800	1728	1080
SDTV	720	576	1350	1080
	720	480	1620	1080
HDTV	1280	720	1920	1080
	1920	1080	1920	1080

USING THE PROJECTOR

WUXGA scaling table for 1920x1200 DMD (screen type 16:10):

Note:

- Supported screen type 16:10 (1920x1200), 16:9 (1920x1080). 4:3 (1600x1200).
- When screen type is 16:9, the 4x3 format and the 16x10 format becomes unavailable.
- When screen type is 16:10, the 4x3 format and the 16x9 format becomes unavailable.
- When screen type is 4:3, the 16x9 format and the 16x10 format becomes unavailable.

16 : 10 screen	PC	480i/p	576i/p	720p	1080i/p
16x10	Scale to 1920x1200.				
LBX	Scale to 1920x1440, then get the central 1920x1200 image to display.				
Native mode	- 1:1 mapping centered. - No scaling will be made; the image is displayed with the resolution based on input source.				
Auto	- If this format is selected, the screen type will automatically become 16:10 (1920x1200). - If source is 4:3, the screen type will be scaled to 1600x1200. - If source is 16:9, the screen type will be scaled to 1920x1080. - If source is 16:10, the screen type will be scaled to 1920x1200.				

WUXGA auto mapping rule (screen type 16:10):

Auto	Input resolution		Auto/Scale	
	H-resolution	V-resolution	1920	1200
4:3	640	480	1600	1200
	800	600	1600	1200
	1024	768	1600	1200
	1280	1024	1600	1200
	1400	1050	1600	1200
	1600	1200	1600	1200
Wide Laptop	1280	720	1920	1080
	1280	768	1920	1152
	1280	800	1920	1200
SDTV	720	576	1500	1200
	720	480	1800	1200
HDTV	1280	720	1920	1080
	1920	1080	1920	1080

WUXGA scaling table (screen type 16:9):

16 : 9 screen	PC	480i/p	576i/p	720p	1080i/p
16x9	Scale to 1920x1080.				
LBX	Scale to 1920x1440, then get the central 1920x1080 image to display.				
Native mode	- 1:1 mapping centered. - No scaling will be made; the image is displayed with the resolution based on input source.				
Auto	- If this format is selected, the screen type will automatically become 16:9 (1920x1080). - If source is 4:3, the screen type will be scaled to 1440x1080. - If source is 16:9, the screen type will be scaled to 1920x1080. - If source is 16:10, the screen type will be scaled to 1920x1200 and cut 1920x1080 area to display.				

USING THE PROJECTOR

WUXGA auto mapping rule (screen type 16:9):

Auto	Input resolution		Auto/Scale	
	H-resolution	V-resolution	1920	1080
4:3	640	480	1440	1080
	800	600	1440	1080
	1024	768	1440	1080
	1280	1024	1440	1080
	1400	1050	1440	1080
	1600	1200	1440	1080
Wide Laptop	1280	720	1920	1080
	1280	768	1800	1080
	1280	800	1728	1080
SDTV	720	576	1350	1080
	720	480	1620	1080
HDTV	1280	720	1920	1080
	1920	1080	1920	1080

WUXGA scaling table (screen type 4:3):

4 : 3 screen	480i/p	576i/p	720p	1080i/p
4x3	Scale to 1600x1200.			
LBX	Scale to 1920x1440, then get the central 1920x1200 image to display.			
Native mode	<ul style="list-style-type: none"> - 1:1 mapping centered. - No scaling will be made; the image is displayed with the resolution based on input source. 			
Auto	<ul style="list-style-type: none"> - If this format is selected, the screen type will automatically become 16:10 (1920x1200). - If source is 4:3, the screen type will be scaled to 1600x1200. - If source is 16:9, the screen type will be scaled to 1920x1080. - If source is 16:10, the screen type will be scaled to 1920x1200. 			

WUXGA auto mapping rule (screen type 4:3):

Auto	Input resolution		Auto/Scale	
	H-resolution	V-resolution	1920	1200
4:3	640	480	1600	1200
	800	600	1600	1200
	1024	768	1600	1200
	1280	1024	1600	1200
	1400	1050	1600	1200
	1600	1200	1600	1200
Wide Laptop	1280	720	1600	900
	1280	768	1600	960
	1280	800	1600	1000
SDTV	720	576	1500	1200
	720	480	1600	1066
HDTV	1280	720	1600	900
	1920	1080	1600	900

USING THE PROJECTOR

Geometric Correction

Auto Keystone

Correct keystone digitally to fit the projected image on the area on which you are projecting.

Note:

- *The image size will reduce slightly when adjusting the horizontal and vertical keystone.*
- *When the Auto Keystone is used, the Four Corner Adjustment function will be disabled.*

V Keystone

Adjust image distortion vertically and make a squarer image. Vertical keystone is used to correct a keystone image shape in which the top and bottom are slanted to one of the sides. This is intended for use with vertically on-axis applications.

H Keystone

Adjust image distortion horizontally and make a squarer image. Horizontal keystone is used to correct a keystone image shape in which the left and right borders of the image are unequal in length. This is intended for use with horizontally on-axis applications.

Four Corner Adjustment

This setting allows the projected image to be adjusted from each corner to make a square image when the projection surface is not level.

Reset

Return the factory default setting for geometric correction settings.

Edge Mask

Use this function to remove the video encoding noise on the edge of video source.

Digital Zoom

Use to reduce or magnify an image on the projection screen. Digital Zoom is not the same as optical zoom and can result in degradation of image quality.

Note: *Zoom settings are retained on power cycle of the projector.*

Image Shift

Adjust the projected image position horizontally (H) or vertically (V).

Reset

Return the factory default settings for display settings.

USING THE PROJECTOR

Setup menu

Learn how to set up the projector.

Submenus

- Test Pattern
- Projection Orientation
- Language
- Menu Settings
- High Altitude
- Filter Settings
- Power Settings
- Security
- Keypad Settings
- Startup Logo
- Background Color
- Closed Captioning
- Device Reset

Test Pattern

Select the test pattern from green grid, magenta grid, white grid, white, or disable this function (off).

Projection Orientation

Select the preferred projection between front, rear, ceiling-top, and rear-top.

Language

Select the multilingual OSD menu between English, German, French, Italian, Spanish, Portuguese, Polish, Dutch, Swedish, Norwegian, Danish, Finnish, Greek, Traditional Chinese, Simplified Chinese, Japanese, Korean, Russian, Hungarian, Czechoslovak, Arabic, Thai, Turkish, Farsi, Vietnamese, Indonesian, and Romanian.

Menu Settings

Menu Location

Select the menu location on the display screen.

Menu Timer

Set the duration where the OSD menu stays visible on the screen.

Information Hide

Enable this function to hide the information message.

High Altitude

When "On" is selected, the fans will spin faster. This feature is useful in high altitude areas where the air is thin.

Filter Settings

Filter Usage Hours

Display the filter time.

USING THE PROJECTOR

Optional Filter Installed

Note: Please consult with your local agent regarding the availability of this optional filter.

Set the warning message setting.

- **Yes:** Display warning message after 500 hours of use.

Note: “Filter Usage Hours / Filter Reminder / Filter Reset” will only appear when “Optional Filter Installed” is “Yes”.

- **No:** Turn off warning message.

Filter Reminder

Choose this function to show or hide the warning message when the changing filter message is displayed. The available options include Off, 300hr, 500hr, 800hr, and 1000hr.

Filter Reset

Reset the dust filter counter after replacing or cleaning the dust filter.

Power Settings

Direct Power On

Choose “On” to activate Direct Power mode. The projector will automatically power on when AC power is supplied, without pressing the “Power” key on the projector keypad or on the remote control.

Signal Power On

Choose “On” to activate Signal Power mode. The projector will automatically power on when a signal is detected, without pressing the “Power” key on the projector Keypad or on the remote control.

Note:

- *If the “Signal Power On” option is turned “On”, the power consumption of the projector in standby mode will be over 3W.*
- *This function is applicable with HDMI source.*

Auto Power Off (min.)

Sets the countdown timer interval. The countdown timer will start, when there is no signal being sent to the projector. The projector will automatically power off when the countdown has finished (in minutes).

Sleep Timer (min.)

Sets the countdown timer interval. The countdown timer will start, with or without a signal being sent to the projector. The projector will automatically power off when the countdown has finished (in minutes).

Note: The Sleep Timer is reset every time when the projector is powered off.

Power Mode (Standby)

Set the power mode setting.

- **Active:** Choose “Active” to return to normal standby.
- **Eco:** Choose “Eco.” to save power dissipation further < 0.5W.

USB Power

Enable or disable the USB power function.

12V Trigger

Use this function to enable or disable the trigger.

USING THE PROJECTOR

Note: 3.5mm mini jack that outputs 12V 500mA (max.) for relay system control.

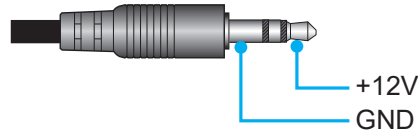

- **On:** Choose “On” to enable the trigger.
- **Off:** Choose “Off” to disable the trigger.

Security

Security

Enable this function to prompt for a password before using the projector.

- **On:** Choose “On” to use security verification when the turning on the projector.
- **Off:** Choose “Off” to be able to switch on the projector without password verification.

Note: The default password is 1234.

Security Timer

Select the time (Month/Day/Hour) function to set the number of hours the projector can be used. Once this time has elapsed you will be requested to enter your password again.

Change Password

Use to set or modify the password that is prompted when turning the projector on.

Keypad Settings

Keypad Lock

When the keypad lock function is “On”, the Keypad will be locked. However, the projector can be operated by the remote control. By selecting “Off”, you will be able to reuse the Keypad.

Startup Logo

Use this function to set the desired startup screen. If changes are made, they will take effect the next time the projector is powered on.

- **Default:** The default startup screen.
- **Neutral:** Logo is not displayed on startup screen.
- **Custom:** User customized logo.

Background Color

Use this function to display a blue, red, green, grey color, none, or logo screen when no signal is available.

Note: If the background color is set to “None”, then the background color is black.

Closed Captioning

Closed Captioning is a text version of the program sound or other information displayed on the screen. If the input signal contains closed captions, you can turn on the feature and watch the channels. The available options include “Off”, “CC1”, and “CC2”.

Device Reset

Reset OSD

Return the factory default settings for OSD menu settings.

Reset All Settings

Return the factory default settings for all settings.

USING THE PROJECTOR

Input menu

Learn how to configure the projector input settings.

Submenus

- Auto Source
- Rename Input Source
- Input Hide
- EDID Settings
- HDMI Out
- HDMI CEC Settings

Auto Source

Choose this option to let the projector automatically find an available input source.

Rename Input Source

Use to rename the input function for easier identification. The available options include HDMI1, HDMI2, VGA 1, VGA 2, Video, and HDBaseT.

Input Hide

Select the input options that you want to hide from the input source menu. The available options include HDMI1, HDMI2, VGA 1, VGA 2, Video, and HDBaseT.

EDID Settings

Set the EDID compatibility.

- **HDMI 1 EDID / HDMI 2 EDID:** When receiving a HDMI signal, set the projector's EDID compatibility to display the signal correctly. Select 1.4 for the input devices with HDMI 1.4, or 2.0 for HDMI 2.0 devices.
- **HDBaseT:** When receiving a HDMI signal via HDBaseT, set the projector's EDID compatibility to display the signal correctly. Select 1.4 for the input devices with HDMI 1.4, or 2.0 for HDMI 2.0 devices.

HDMI Out

Select the HDMI port to output the signal.

HDMI CEC Settings

Note: When you connect HDMI CEC-compatible devices to the projector with HDMI cables, you can control them on the same power on or power off status using the HDMI Link control feature in the projector's OSD. This lets one device or multiple devices in a group power on or power off via HDMI Link Feature in a typical configuration, your DVD player may be connected to the projector through an amplifier or home theater system.

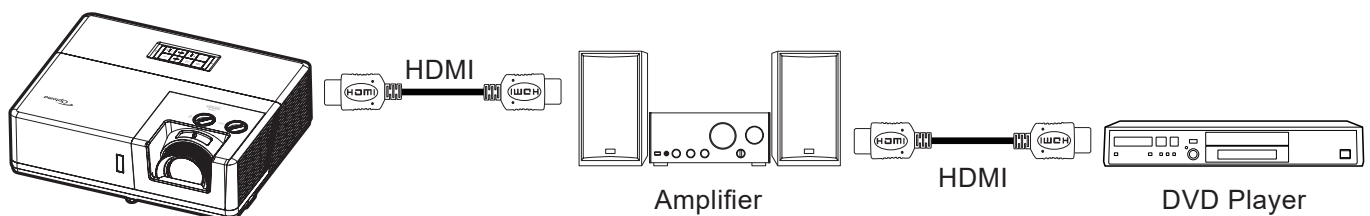

HDMI Link

Enable/disable the HDMI Link function.

Inclusive of TV

If the settings is set to "Yes" then the power on and power off link options are available.

USING THE PROJECTOR

Power On Link

CEC power on command.

- **Mutual:** Both projector and CEC device will be turned on simultaneously.
- **PJ → Device:** The CEC device will be turned on only after the projector is switched on.
- **Device → PJ:** The projector will be switched on only after the CEC device is turned on.

Power Off Link

Enable this function to let both HDMI Link and projector to be automatically turned off at the same time.

Reset

Return the factory default settings for input settings.

USING THE PROJECTOR

Audio menu

Learn how to configure audio settings.

Submenus

- Volume
- Mute
- Audio Output
- Audio Input

Volume

Adjust the volume level.

Mute

Use this option to temporarily turn off the sound.

- **Off:** Choose “Off” to turn mute off.
- **On:** Choose “On” to turn mute on.

Note: “Mute” function affects both internal and external speaker volume.

Audio Output

Select the audio output between Internal Speaker and Line Out.

Audio Input

Select the appropriate audio input source.

- **HDMI 1 / HDMI 2 / HDBaseT:** The available options include Audio 1, Audio 2, and Default.
- **VGA 1 / VGA 2 / Video:** The available options include Audio 1 and Audio 2.

Reset

Return the factory default settings for audio settings.

USING THE PROJECTOR

Control menu

Control menu is used to configure the settings that allow the projector to communicate with other projectors or control devices.

Submenus

- Device ID
- Remote Settings
- LAN
- Control
- HDBaseT Control

Supplemental information

- Using the web control panel
- Using RS232 command by Telnet

Device ID

ID definition can be set up by menu (range 0-99), and allow user control an individual projector by using RS232 command.

Note: For a full list of RS232 commands, please refer to the RS232 user manual on our website.

Remote Settings

IR Function

Set the IR function setting.

- **On:** Choose "On", the projector can be operated by the remote control from the top and front IR receivers.
- **Front:** Choose "On", the projector can be operated by the remote control from the front IR receiver.
- **Top:** Choose "On", the projector can be operated by the remote control from the top IR receiver.
- **Off:** Choose "Off", the projector can't be operated by the remote control. By selecting "Off", you will be able to use the Keypad keys.

Remote Code

Set the remote custom code by pressing the remote ID button for 3 seconds and you will notice the remote indicator (above the Off button) starts blinking. Then, input a number between 00-99 using the keyboard numbered keys. After inserting the number, the remote indicator blinks twice quickly indicating that the remote code has changed.

F1 / F2 / F3

Assign a function to the F1, F2, and F3 buttons on the remote control. It allows you to use the function easily without going through the OSD menus. The available functions are HDMI 1, HDMI 2, Test Pattern, Brightness, Contrast, Sleep Timer, CMS, Color Temperature, Gamma, Projection, Light Source Mode, Zoom, or Freeze.

LAN

Configure the projector's network settings.

Network Status

Display the network connection status. (Read only)

MAC Address

Display the MAC address. (Read only)

DHCP

Turn on DHCP to automatically acquire IP address, subnet mask, gateway, and DNS.

USING THE PROJECTOR

IP Address

Assign the projector's IP address.

Subnet Mask

Assign the projector's subnet mask.

Gateway

Assign the projector's gateway.

DNS

Assign the projector's DNS.

Reset

Reset the network settings to default factory values.

Control

This projector can be controlled remotely by a computer or other external devices through the wired network connection. It allows the user to control one or more projectors from a remote control center, such as powering the projector on or off, and adjusting the image brightness or contrast.

Use the Control submenu to select a control device for the projector.

Crestron

Control the projector with Crestron controller and related software. (Port: 41794)

For more information, please visit <http://www.crestron.com>.

Extron

Control the projector with Extron devices. (Port: 2023)

For more information, please visit <http://www.extron.com>.

PJ Link

Control the projector with PJLink v2.0 commands. (Port: 4352)

For more information, please visit <http://pjlink.jbmia.or.jp/english>.

AMX Device Discovery

Control the projector with AMX devices. (Port: 9131)

For more information, please visit <http://www.amx.com>.

Telnet

Control the projector using RS232 commands through Telnet connection. (Port: 23)

For more information, refer to "RS232 by Telnet Function" on page 58.

HTTP

Control the projector with web browser. (Port: 80)

For more information, refer to "How to use web browser to control your projector" on page 51.

Note:

- *Crestron is a registered trademark of Crestron Electronics, Inc. of the United States.*
- *Extron is a registered trademark of Extron Electronics, Inc. of the United States.*
- *AMX is a registered trademark of AMX LLC of the United States.*
- *PJLink applied for trademark and logo registration in Japan, the United States of America, and other countries by JBMIA.*
- *For more information about the various types of external devices which can be connected to the LAN / RJ45 port and remotely control the projector, as well as the supported commands for these external devices, please contact the Support-Service directly.*

USING THE PROJECTOR

Setup Network Control

LAN RJ45 function

For simplicity and ease of operation, the projector provides diverse networking and remote management features. The LAN / RJ45 function of the projector through a network, such as remotely manage: Power On / Off, brightness, and contrast settings. Also, you can view the projector status information, such as: Video- Source, Sound-Mute, etc.

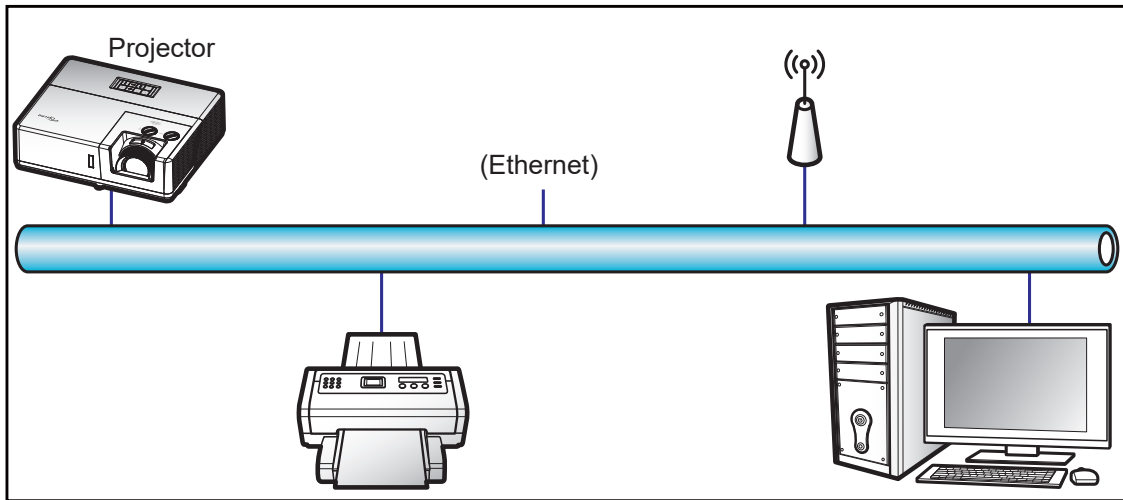

Wired LAN terminal functionalities

This projector can be controlled by using a PC (laptop) or other external device via LAN / RJ45 port and compatible with Crestron / Extron / AMX (Device -Discovery) / PJLink.

- Crestron is a registered trademark of Crestron Electronics, Inc. of the United States.
- Extron is a registered trademark of Extron Electronics, Inc. of the United States.
- AMX is a registered trademark of AMX LLC of the United States.
- PJLink applied for trademark and logo registration in Japan, the United States of America, and other countries by JBMIA.

The projector is supported by the specified commands of the Crestron Electronics controller and related software, for example RoomView®.

<http://www.crestron.com/>

This projector is compliant to support Extron device(s) for reference.

<http://www.extron.com/>

This projector is supported by AMX (Device Discovery).

<http://www.amx.com/>

This projector supports all commands of PJLink Class 2.

<http://pjlink.jbmia.or.jp/english/>

For more detailed information about the various types of external devices which can be connected to the LAN / RJ45 port and remote control the projector, as well as the supported commands for these external devices, please contact the Support-Service directly.

USING THE PROJECTOR

How to use web browser to control your projector

1. Turn “On” the DHCP option on projector to allow a DHCP server to automatically assign an IP address.
2. Open the web browser in your PC and type in the projector’s IP address (“Control > LAN > IP Address”).
3. Enter the user name and password, and click “Login”.
The projector’s configuration web interface opens.

Note:

- The default user name and password is “admin”.
- The steps in this section is based on Windows 10 operating system.

Making a direct connection from your computer to the projector*

1. Turn “Off” the DHCP option on the projector.
2. Configure the IP address, Subnet Mask, Gateway, and DNS on projector (“Control > LAN”).
3. Open **Network & Internet** page on your PC, and assign the identical network parameters to your PC as set on projector. Click “OK” to save the parameters.

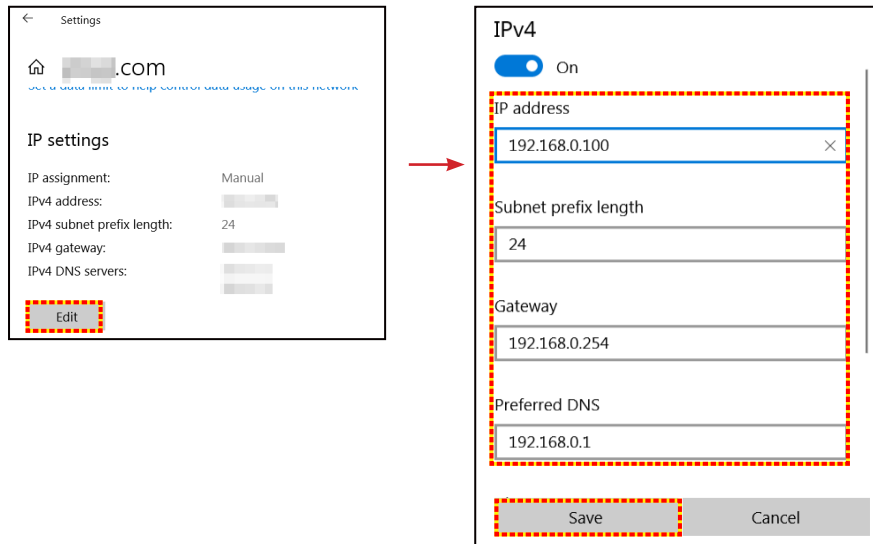

4. Open the web browser on your PC and type in to the URL field the IP address, assigned in step 3. Then press “Enter” key.

USING THE PROJECTOR

LAN RJ45

1. Connect an RJ45 cable to RJ45 ports on the projector and the PC (laptop).

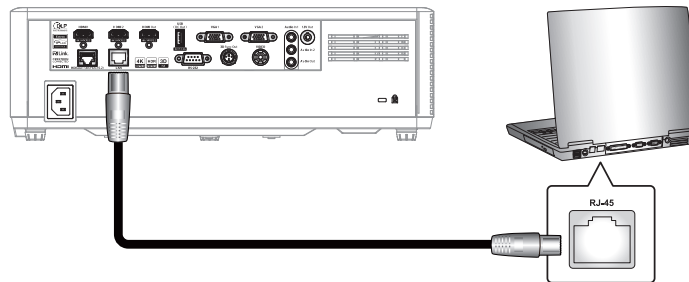

2. On the PC (Laptop), select **Start**  **Settings**  **> Network & Internet**.

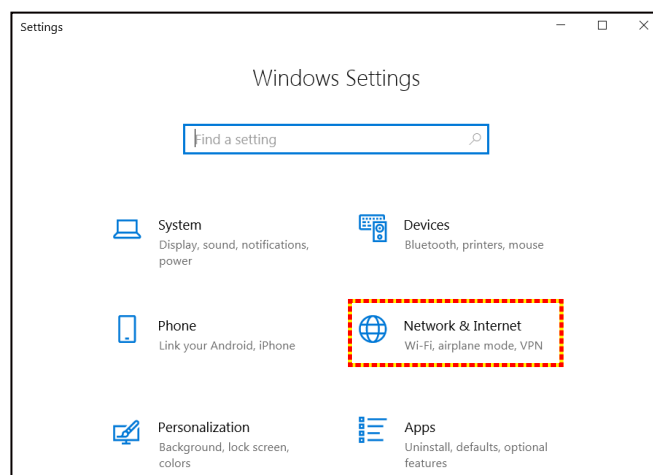

3. In the **Ethernet** section, select **Properties**.

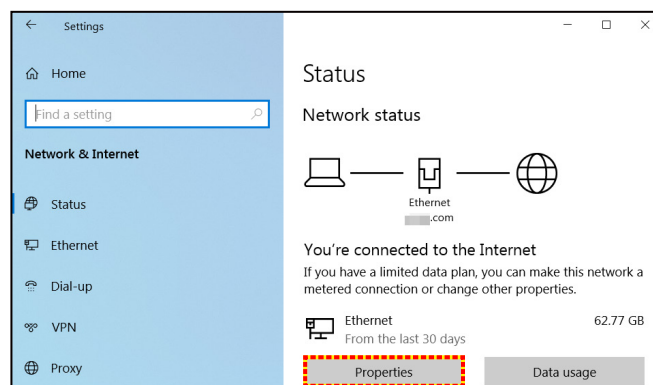

4. In the **IP settings** section, select **Edit**.

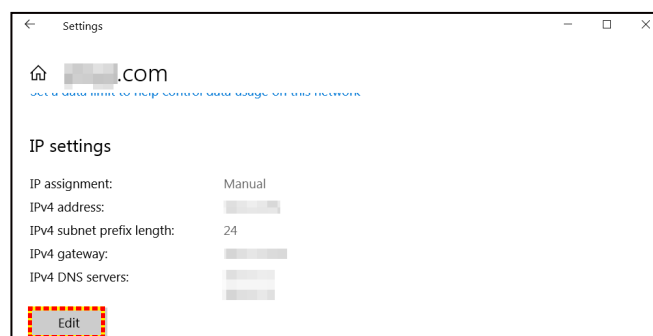

USING THE PROJECTOR

5. Type in the IP address and Gateway, then select “Save”.

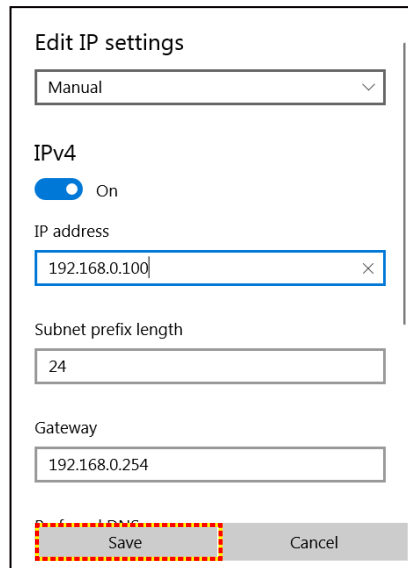

Edit IP settings

Manual

IPv4

On

IP address

192.168.0.100

Subnet prefix length

24

Gateway

192.168.0.254

Save Cancel

6. Press the “Menu” button on the projector.
7. Open on projector **Control > LAN**.
8. Enter the following connection parameters:
 - DHCP: Off
 - IP Address: 192.168.0.100
 - Subnet Mask: 255.255.255.0
 - Gateway: 192.168.0.254
 - DNS: 192.168.0.51
9. Press “Enter” to confirm settings.
10. Open a web browser, for example Microsoft Edge or Chrome with Adobe Flash Player 9.0 or higher installed.
11. In the Address bar, input the projector’s IP address: 192.168.0.100.

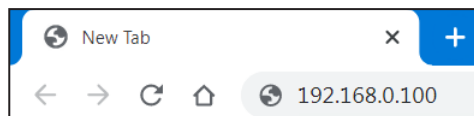

12. Press “Enter”.

USING THE PROJECTOR

The projector is setup for remote management. The LAN / RJ45 function displays as follows:

Log in

When you open the web page for the first time, you will see a screen like the one below. Please enter valid user password.

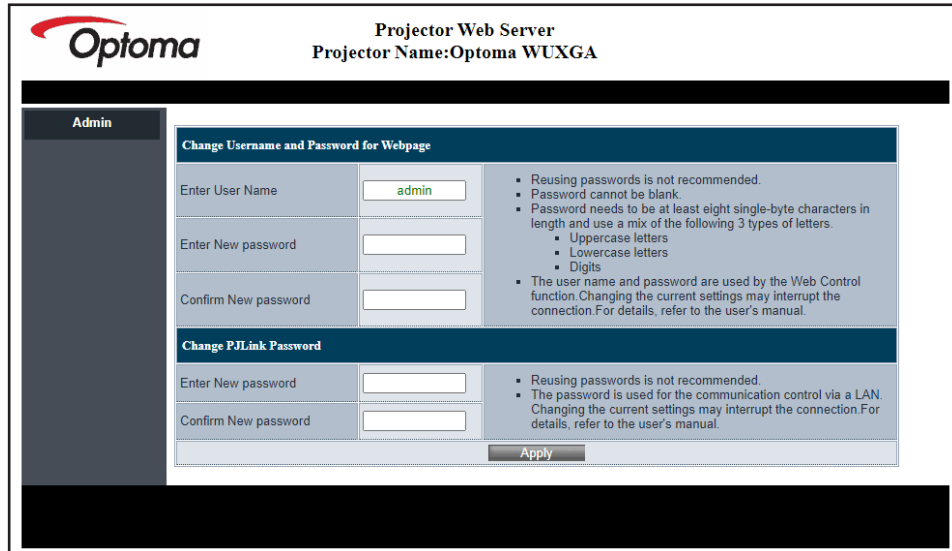

The screenshot shows the 'Admin' interface of the 'Projector Web Server' for 'Optoma WUXGA'. It features two main sections for password management:

- Change Username and Password for Webpage:** Includes fields for 'Enter User Name' (containing 'admin'), 'Enter New password', and 'Confirm New password'. A list of requirements is provided: reusing passwords is not recommended; passwords cannot be blank; passwords must be at least eight characters long and include uppercase letters, lowercase letters, and digits. A note states that these settings are used by the Web Control function and changing them may interrupt the connection.
- Change PJLink Password:** Includes fields for 'Enter New password' and 'Confirm New password'. Requirements state that reusing passwords is not recommended and that the password is used for LAN communication control, with a note that changing settings may interrupt the connection.

An 'Apply' button is located at the bottom of the form area.

When you open the web page after entering a valid password, you will see a screen like the one below. Enter the password in the "Password" field.

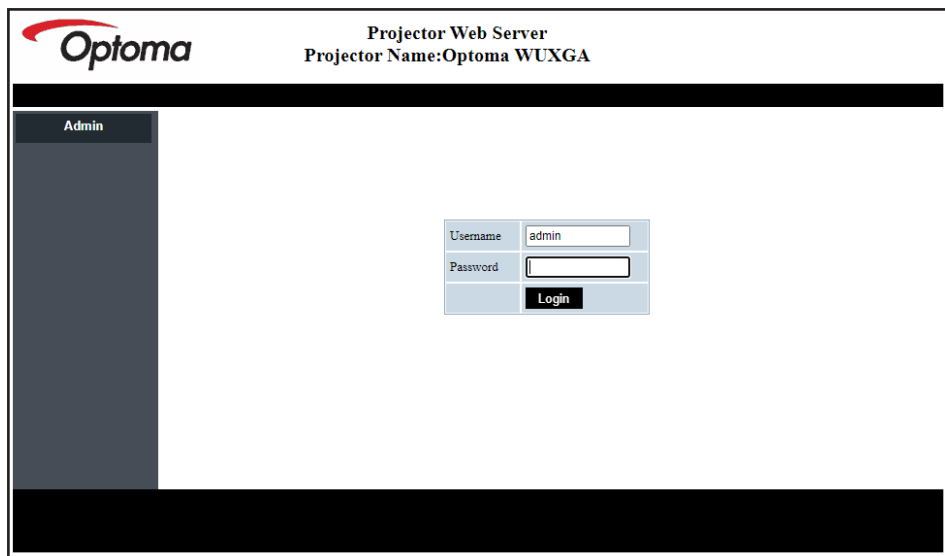

The screenshot shows the 'Admin' interface after a successful login. The 'Username' field is pre-filled with 'admin', and the 'Password' field is empty. A 'Login' button is positioned below the password field.

USING THE PROJECTOR

System Status

The current status of the projector is displayed. You can check projector model name, firmware version, current LAN configuration, and change the interface language if needed.

The version name displayed on the web page in the diagram may differ from the actual display.

The screenshot shows the 'System Status' page of the Projector Web Server. The page title is 'Projector Web Server' with the projector name 'Optoma WUXGA'. A 'Logout' button is in the top right. The left sidebar contains navigation options: System Status, General Setup, Projector Control, Network Setup, Alert Setup, Crestron, Reset to Default, and Reboot System. The main content area displays a table of system information:

Model Name	Optoma WUXGA
Projector Name	Optoma WUXGA
FW Version	
System	C03
LAN	L04
LAN Status	
IP Address	192.168.0.100
Subnet Mask	255.255.255.0
Default Gateway	192.168.0.254
MAC Address	00:50:41:C0:00:1C

Below the table is a language selection dropdown set to 'English' and an 'Apply' button.

General Setup

The projector name set here is also used in PJLink control. Only alphanumeric characters can be used as projector name. The maximum number of characters is 32.

You can use only alphanumeric characters in the password. The minimum number of characters is 8. If you enter an invalid character, "Invalid Character" warning is displayed.

If the characters of new password and the characters of confirm (new) password do not match, error message will be displayed. In this case, re-enter the password.

The screenshot shows the 'General Setup' page of the Projector Web Server. The page title is 'Projector Web Server' with the projector name 'Optoma WUXGA'. A 'Logout' button is in the top right. The left sidebar contains navigation options: System Status, General Setup, Projector Control, Network Setup, Alert Setup, Crestron, Reset to Default, and Reboot System. The main content area includes:

- Projector Name:** A text field containing 'Optoma WUXGA' and an 'Apply' button.
- Change Username and password for Webpage:**
 - Enter Username:** A text field containing 'admin'.
 - Enter Old password:** A text field.
 - Enter New password:** A text field.
 - Confirm New password:** A text field.
 - Apply** button.
 - Help text:**
 - Reusing passwords is not recommended.
 - Password cannot be blank.
 - Password needs to be at least eight single-byte characters in length and use a mix of the following 3 types of letters:
 - Uppercase letters
 - Lowercase letters
 - Digits
 - The user name and password are used by the Web Control function. Changing the current settings may interrupt the connection. For details, refer to the user's manual.
- PJLink Setting:**
 - PJLink Password:** Radio buttons for 'Enable' and 'Disable' (selected).
 - Current Password:** A text field.
 - New Password:** A text field.
 - Confirm Password:** A text field.
 - Apply** button.
 - Help text:**
 - Reusing passwords is not recommended.
 - The password is used for the communication control via a LAN. Changing the current settings may interrupt the connection. For details, refer to the user's manual.

USING THE PROJECTOR

Projector Control

You can control the projector with this item. The items for control are described in this section.

Control button: When you click a button, the corresponding function will be performed.

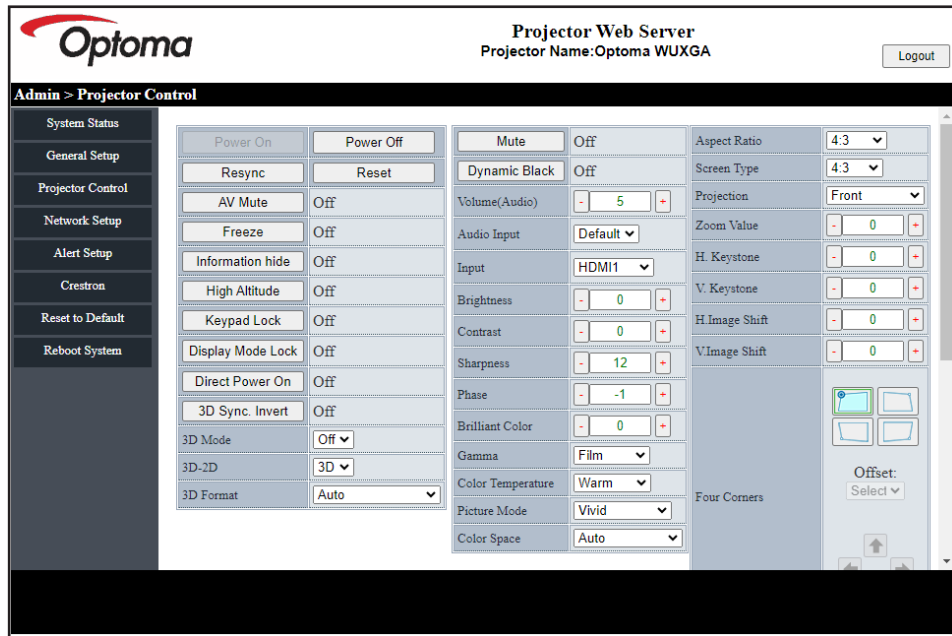

Network Setup

Set the network of the projector.



USING THE PROJECTOR

Alert Setup

You can send email alerts when an error occurs. You can carry out settings for alert mail in this section.

1. Alert types: Check the type of error for which you want to send alert mail.
2. Alert mail notification: Check and perform the following settings:
 - SMTP Setting: Set the following:
 - a) SMTP Server: Server address (server name) (SMTP server)
 - b) From: e-mail address of the sender
 - c) User Name: User name of the mail server
 - d) Password: Mail server password.
 - Email Setting: Set the following:
 - a) Mail Subject
 - b) Mail Content
 - c) To: Enter the e-mail address of the sender.
3. Click "Apply" to fix the value.
4. Enter the IP address of projector in *xxx.xxx.xxx.xxx.
5. Send Test Mail.

When you click [Send Test Mail], test email will be sent. The text will be "Email Test xxx.xxx.xxx.xxx *".

The screenshot shows the 'Admin > Alert Setup' interface of the Optoma Projector Web Server. The page title is 'Projector Web Server' with the projector name 'Optoma WUXGA' and a 'Logout' button. A sidebar on the left contains navigation links: System Status, General Setup, Projector Control, Network Setup, Alert Setup (highlighted), Crestron, Reset to Default, and Reboot System. The main content area is divided into sections: 'Alert Type' with checkboxes for 'Fan Error', 'High Temp Warning', and 'Light Source Error'; 'Alert Mail Notification' which is checked; 'SMTP Setting' with input fields for 'SMTP Server', 'From', 'Username', and 'Password'; and 'Email Setting' with input fields for 'Mail Subject', 'Mail Content', and 'To'. At the bottom right of the form are 'Apply' and 'Send Test Mail' buttons.

USING THE PROJECTOR

RS232 by Telnet Function

As an alternative method of control, this projector has RS232 command control by TELNET for LAN / RJ45 interface.

Quick Start-Guide for “RS232 by Telnet”

- Check and get the IP address on OSD of the projector.
 - Make sure that the PC / laptop can access the web-page of the projector.
 - Make sure that “Windows Firewall” setting is set to disabled in case of “TELNET” function filtering out by PC / laptop.
1. Click on **Search**  and then enter “cmd” as a search word. Press the “Enter” key.

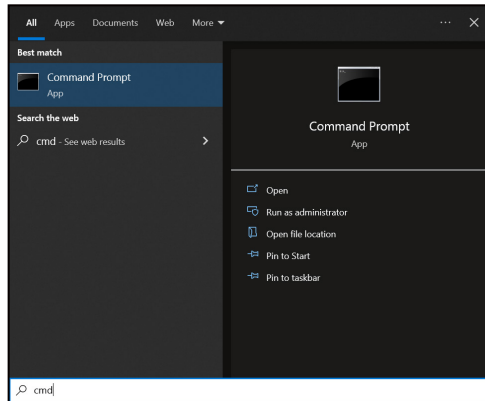

2. Open the Command Prompt app.
3. Input the command format as follows:
 - telnet ttt.xxx.yyy.zzz 23 (“Enter” key pressed)
 - (ttt.xxx.yyy.zzz: IP-Address of the projector)
4. If Telnet-Connection ready, and user can have RS232 command input, then press the “Enter” key and Telnet connection should be ready for RS232 command control.

Specification for “RS232 by TELNET”:

1. Telnet: TCP.
2. Telnet port: 23 (for further details, please contact the Optoma service team).
3. Telnet utility: Windows “TELNET.exe” (console mode).
4. To end the Telnet session, just close the Command Prompt app window.
5. Windows Telnet utility directly after TELNET connection ready.
 - Limitation 1 for Telnet-Control: There cannot be more than 50 bytes for successive network payload for Telnet-Control application.
 - Limitation 2 for Telnet-Control: There cannot be more than 26 bytes for successive RS232 command for Telnet-Control.
 - Limitation 3 for Telnet-Control: Minimum delay for next command must be more than 200 (ms).

USING THE PROJECTOR

HDBaseT Control

Ethernet / RS232

The projector can automatically detect the Ethernet or RS232 signal from the HDBaseT transmitter supplied. For an automatic detection, make sure the respective signal is enabled.

Reset

Return the factory default settings for control settings.

Information menu

View the projector information about its status and settings. The projector information is read only.

- Regulatory
- Serial Number
- Source Info.
- Picture Mode
- Color Info.
- Power Mode (Standby)
- Light Source Hours
- Light Source Mode
- Remote Code
- Remote Code (Active)
- Device ID
- IP Address
- Network Status
- FW Version

ADDITIONAL INFORMATION

Compatible resolutions

Video Compatibility

Signal	Resolution
NTSC	NTSC M / J, 3.58 MHz, 4.43 MHz
PAL	PAL B / D / G / H / I / M / N, 4.43 MHz
SECAM	SECAM B / D / G / K / K1 / L, 4.25 / 4.4 MHz
SDTV	480i/p, 576i/p
HDTV	720p(50/60 Hz), 1080i(50/60 Hz), 1080p(50/60 Hz)

Video timing in details:

Signal	Resolution	Refresh Rate(Hz)	Notes for Mac
TV(NTSC)	720x480	60	For composite video
TV(PAL,SECAM)	720x576	50	
SDTV(480I)	720x480	60	
SDTV(480p)	720x480	60	For Component
SDTV(576I)	720x576	50	
SDTV(576p)	720x576	50	
HDTV(720p)	1280x720	50 / 60	
HDTV(1080I)	1920x1080	50 / 60	
HDTV(1080p)	1920x1080	24 / 50 / 60	

Computer compatibility

Timing table for PC:

Signal	Resolution	Refresh Rate(Hz)	Notes for Mac
VGA	640x480	60/67/72/75	Mac 60/75
	720x400	70	
SVGA	800x600	56/60(*2)/72/75	Mac 60/75
	832x624	75	Mac 75
XGA	1024x768	60(*2)/70/75/120(*2)	Mac 60/70/75
HDTV(720p)	1280x720	60(*2)/120(*2)	Mac 60
WXGA	1280x800	60	Mac 60
WXGA(*3)	1366x768	60	
SXGA	1280x1024	60/75	Mac 60/75
	1440x900	60	
SXGA+	1400x1050	60	
UXGA	1600x1200	60	
WUXGA	1920x1200(*1)	60	Mac 60

Note:

- (*1) 1920x1200 @60hz only support RB(reduced blanking).
- (*2) 3D timing for 3D Ready projector(STD) and True 3D projector(Option).
- (*3) Windows 8 standard timing.

ADDITIONAL INFORMATION

Input Signal for HDMI:

Signal	Resolution	Refresh Rate(Hz)	Notes for Mac
VGA	640x480	60/67/72/75	Mac 60/75
	720x400	70	
SVGA	800x600	56/60(*2)/72/75	Mac 60/75
	832x624	75	Mac 75
XGA	1024x768	60(*2)/70/75/120(*2)	Mac 60/70/75
SDTV(480p)	720x480	60	
SDTV(576p)	720x576	50	
HDTV(720p)	1280x720	60(*2)/120(*2)	Mac 60
WXGA	1280x800	60	Mac 60
	1440x900	60	
WXGA(*3)	1366x768	60	
SXGA	1280x1024	60/75	Mac 60/75
	1440x900	60	
SXGA+	1400x1050	60	
UXGA	1600x1200	60	
HDTV(1080i)	1920x1080	50/60	
HDTV(1080p)	1920x1080	24/25/30/50/60/120	Mac 60
WUXGA	1920x1200(*1)	60	Mac 60
UHD(2160p)	3840x2160	24/25/30/50/60	
	4096x2160	24/25/30/50/60	

Note:

- (*1) 1920x1200 @60 Hz only support RB(reduced blanking).
- (*2) 3D timing for 3D Ready projector(STD) and True 3D projector(Option).
- (*3) Windows 8 standard timing.

ADDITIONAL INFORMATION

True 3D Video Compatibility

		Input timing			
		Input resolutions	HDMI 1.4a 3D Input	1280x720p @50 Hz	Top-and-Bottom
1280x720p @60 Hz	Top-and-Bottom				
1280x720p @50 Hz	Frame packing				
1280x720p @60 Hz	Frame packing				
1920x1080i @50 Hz	Side-by-Side(Half)				
1920x1080i @60 Hz	Side-by-Side(Half)				
1920x1080p @24 Hz	Top-and-Bottom				
1920x1080p @24 Hz	Frame packing				
HDMI 1.3	1920x1080i @50 Hz			Side-by-Side(Half)	SBS mode is on
	1920x1080i @60 Hz				
	1280x720p @50 Hz				
	1280x720p @60 Hz				
	800x600 @60 Hz				
	1024x768 @60 Hz				
	1280x800 @60 Hz		Top-and-Bottom	TAB mode is on	
	1920x1080i @50 Hz				
	1920x1080i @60 Hz				
	1280x720p @50 Hz				
1280x720p @60 Hz					
800x600 @60 Hz					
1024x768 @60 Hz					
1280x800 @60 Hz					
480i	HQFS	3D format is Frame sequential			

Note:

- If 3D input is 1080p @24 Hz, the DMD should replay with integral multiple with 3D mode.
- 1080i @25 Hz and 720p @50 Hz will run in 100 Hz; other 3D timing will run in 120 Hz.
- 1080p @24 Hz will run 144 Hz.

ADDITIONAL INFORMATION

EDID (Analog)

VGA			
B0 / Established Timing	B0 / Standard Timing	B0 / Detail Timing	B1 / Detail Timing
720x400 @70 Hz	1024x768 @120 Hz	Native timing:	1366x768 @60 Hz
640x480 @60 Hz	1280x720 @60 Hz	1920x1200 @60 Hz	1920x1080 @60 Hz
640x480 @67 Hz	1280x720 @120 Hz		
640x480 @72 Hz	1280x800 @60 Hz		
640x480 @75 Hz	1280x1024 @60 Hz		
800x600 @56 Hz	1440x900 @60 Hz		
800x600 @60 Hz	1400x1050 @60 Hz		
800x600 @72 Hz	1600x1200 @60 Hz		
800x600 @75 Hz			
832x624 @75 Hz			
1024x768 @60 Hz			
1024x768 @70 Hz			
1024x768 @75 Hz			
1280x1024 @75 Hz			
1152x870 @75 Hz			

EDID (Digital)

HDMI 1/2 for 1.4b				
B0 / Established Timing	B0 / Standard Timing	B0 / Detail Timing	B1 / Video Mode	B1 / Detail Timing
720x400 @70 Hz	1024x768 @120 Hz	Native timing:	640x480p 4:3 @60 Hz	1366x768 @60 Hz
640x480 @60 Hz	1280x720 @60 Hz	1920x1200 @60 Hz	720(1440)x576i 4:3 @50 Hz	1920x1080 @60 Hz
640x480 @67 Hz	1280x720 @120 Hz		720(1440)x576i 16:9 @50 Hz	
640x480 @72 Hz	1280x800 @60 Hz		720(1440)x480i 4:3 @60 Hz	
640x480 @75 Hz	1280x1024 @60 Hz		720(1440)x480i 16:9 @60 Hz	
800x600 @56 Hz	1440x900 @60 Hz		720x576p 4:3 @50 Hz	
800x600 @60 Hz	1400x1050 @60 Hz		720x576p 16:9 @50 Hz	
800x600 @72 Hz	1600x1200 @60 Hz		720x480p 4:3 @60 Hz	
800x600 @75 Hz			720x480p 16:9 @60 Hz	
1024x768 @60 Hz			1280x720p 16:9 @50 Hz	
1024x768 @70 Hz			1280x720p 16:9 @60 Hz	
1024x768 @75 Hz			1920x1080i 16:9 @60 Hz	
1280x1024 @75 Hz			1920x1080i 16:9 @50 Hz	
1152x870 @75 Hz			1920x1080p 16:9 @24 Hz	
832x624 @75 Hz			1920x1080p 16:9 @25 Hz	
			1920x1080p 16:9 @30 Hz	
			1920x1080p 16:9 @50 Hz	
			1920x1080p 16:9 @60 Hz	
			1920x1080p 16:9 @120 Hz	
			3840x2160p 16:9 @24 Hz	
			3840x2160p 16:9 @25 Hz	
			3840x2160p 16:9 @30 Hz	
			4096x2160p 256:135 @24 Hz	
			4096x2160p 256:135 @25 Hz	
			4096x2160p 256:135 @30 Hz	

ADDITIONAL INFORMATION

HDMI 1/2 for 2.0				
B0 / Established Timing	B0 / Standard Timing	B0 / Detail Timing	B1 / Video Mode	B1 / Detail Timing
720x400 @70 Hz	1024x768 @120 Hz	Native timing:	640x480p 4:3 @60 Hz	1366x768 @60 Hz
640x480 @60 Hz	1280x720 @60 Hz	1920x1200 @60 Hz	720(1440)x576i 4:3 @50 Hz	1920x1080 @60 Hz
640x480 @67 Hz	1280x720 @120 Hz		720(1440)x576i 16:9 @50 Hz	
640x480 @72 Hz	1280x800 @60 Hz		720(1440)x480i 4:3 @60 Hz	
640x480 @75 Hz	1280x1024 @60 Hz		720(1440)x480i 16:9 @60 Hz	
800x600 @56 Hz	1440x900 @60 Hz		720x576p 4:3 @50 Hz	
800x600 @60 Hz	1400x1050 @60 Hz		720x576p 16:9 @50 Hz	
800x600 @72 Hz	1600x1200 @60 Hz		720x480p 4:3 @60 Hz	
800x600 @75 Hz			720x480p 16:9 @60 Hz	
1024x768 @60 Hz			1280x720p 16:9 @50 Hz	
1024x768 @70 Hz			1280x720p 16:9 @60 Hz	
1024x768 @75 Hz			1920x1080i 16:9 @60 Hz	
1280x1024 @75 Hz			1920x1080i 16:9 @50 Hz	
1152x870 @75 Hz			1920x1080p 16:9 @24 Hz	
832x624 @75 Hz			1920x1080p 16:9 @25 Hz	
			1920x1080p 16:9 @30 Hz	
			1920x1080p 16:9 @50 Hz	
			1920x1080p 16:9 @60 Hz	
			1920x1080p 16:9 @120 Hz	
			3840x2160p 16:9 @24 Hz	
			3840x2160p 16:9 @25 Hz	
			3840x2160p 16:9 @30 Hz	
			3840x2160p 16:9 @50 Hz	
			3840x2160p 16:9 @60 Hz	
			4096x2160p 256:135 @24 Hz	
			4096x2160p 256:135 @25 Hz	
			4096x2160p 256:135 @30 Hz	
			4096x2160p 256:135 @50 Hz	
			4096x2160p 256:135 @60 Hz	

HDMI 1/2
Audio Date / Format
LPCM(IEC 60958 PCM[30,31])

ADDITIONAL INFORMATION

Image size and projection distance

WUXGA 1.6x lens model

Desired Image Size						Projection Distance			
Diagonal		Width		Height		Wide		Tele	
m	inch	m	inch	m	inch	m	feet	m	feet
0.80	31.5	0.68	26.71	0.42	16.69	/	/	1.3	4.27
1.02	40	0.86	33.92	0.54	21.20	/	/	1.7	5.43
1.27	50	1.08	42.40	0.67	26.50	1.3	4.24	2.1	6.78
1.52	60	1.29	50.88	0.81	31.80	1.6	5.09	2.5	8.14
1.78	70	1.51	59.36	0.94	37.10	1.8	5.94	2.9	9.50
2.03	80	1.72	67.84	1.08	42.40	2.1	6.78	3.3	10.85
2.29	90	1.94	76.32	1.21	47.70	2.3	7.63	3.7	12.21
2.54	100	2.15	84.80	1.35	53.00	2.6	8.48	4.1	13.57
3.05	120	2.58	101.76	1.62	63.60	3.1	10.18	5.0	16.28
3.81	150	3.23	127.20	2.02	79.50	3.9	12.72	6.2	20.35
4.57	180	3.88	152.64	2.42	95.40	4.7	15.26	7.4	24.42
5.08	200	4.31	169.60	2.69	106.00	5.2	16.96	8.3	27.14
6.35	250	5.38	212.00	3.37	132.50	6.5	21.20	/	/
7.65	301	6.48	255.25	4.05	159.53	7.8	25.52	/	/

WUXGA 1.6x lens model

Lens Shift Range (wide)					
Vertical Image Shift			Horizontal Image Shift		
Image Size Diagonal	Vertical + (Top)	Vertical - (Bottom)	Vertical Shift Range	Horizontal + (Right)	Horizontal - (Left)
inch	cm	cm	cm	cm	cm
31.5	50.9	42.4	8.5	6.8	6.8
40	64.6	53.8	10.8	8.6	8.6
50	80.8	67.3	13.5	10.8	10.8
60	96.9	80.8	16.2	12.9	12.9
70	113.1	94.2	18.8	15.1	15.1
80	129.2	107.7	21.5	17.2	17.2
90	145.4	121.2	24.2	19.4	19.4
100	161.5	134.6	26.9	21.5	21.5
120	193.9	161.5	32.3	25.8	25.8
150	242.3	201.9	40.4	32.3	32.3
180	290.8	242.3	48.5	38.8	38.8
200	323.1	269.2	53.8	43.1	43.1
250	403.9	336.5	67.3	53.8	53.8
301	486.2	405.2	81.0	64.8	64.8

ADDITIONAL INFORMATION

WUXGA Short Throw model

Desired Image Size						Projection Distance	
Diagonal		Width		Height		Wide	
m	inch	m	inch	m	inch	m	feet
0.76	30	0.65	25.4	0.40	15.9	0.37	1.2
1.02	40	0.86	33.9	0.54	21.2	0.50	1.6
1.27	50	1.08	42.4	0.67	26.5	0.62	2.0
1.52	60	1.29	50.9	0.81	31.8	0.75	2.5
1.78	70	1.51	59.4	0.94	37.1	0.87	2.9
2.03	80	1.72	67.8	1.08	42.4	1.00	3.3
2.29	90	1.94	76.3	1.21	47.7	1.12	3.7
2.54	100	2.15	84.8	1.35	53.0	1.25	4.1
2.92	115	2.48	97.5	1.55	60.9	1.44	4.7
3.81	150	3.23	127.2	2.02	79.5	1.87	6.1
4.57	180	3.88	152.6	2.42	95.4	2.25	7.4
5.08	200	4.31	169.6	2.69	106.0	2.50	8.2
6.35	250	5.38	212.0	3.37	132.5	3.12	10.2
7.62	300	6.46	254.4	4.04	159.0	3.75	12.3

WUXGA Short Throw model

Lens Shift Range (wide)					
Image Size Diagonal	Vertical Image Shift			Horizontal Image Shift	
	Vertical + (Top)	Vertical - (Bottom)	Vertical Shift Range	Horizontal + (Right)	Horizontal - (Left)
inch	cm	cm	cm	cm	cm
30	44	40	4.0	3.9	3.9
40	59	54	5.4	5.2	5.2
50	74	67	6.7	6.5	6.5
60	89	81	8.1	7.8	7.8
70	104	94	9.4	9.1	9.1
80	118	108	10.8	10.3	10.3
90	133	121	12.1	11.6	11.6
100	148	135	13.5	12.9	12.9
115	170	155	15.5	14.9	14.9
150	222	202	20.2	19.4	19.4
180	267	242	24.2	23.3	23.3
200	296	269	26.9	25.9	25.9
250	370	337	33.7	32.3	32.3
300	444	404	40.4	38.8	38.8

ADDITIONAL INFORMATION

Desired image size:

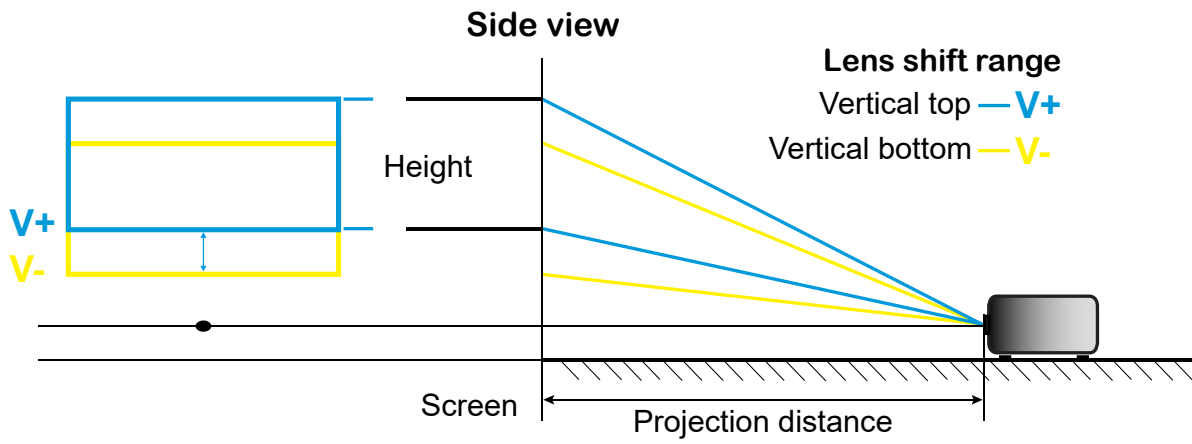

Lens shift range:

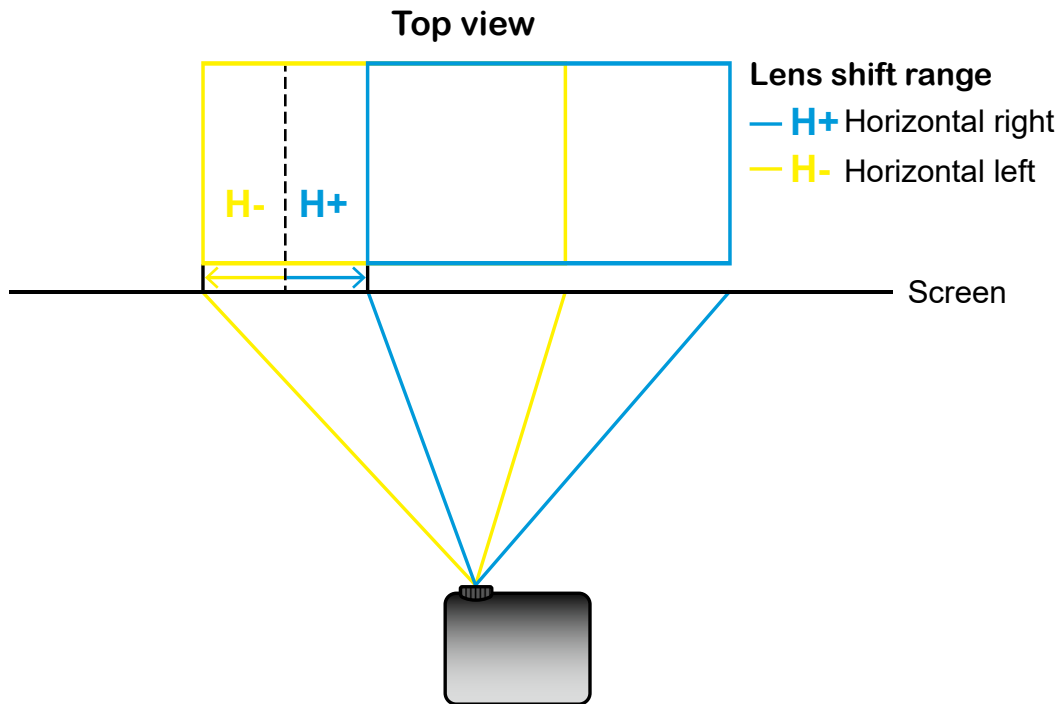

ADDITIONAL INFORMATION

Projector dimensions and ceiling mount installation

1. To prevent damage to your projector, please use the Optoma ceiling mount.
2. If you wish to use a third party ceiling mount kit, please ensure the screws used to attach a mount to the projector meet the following specifications:
 - Screw type: M4*5mm
 - Minimum screw length: 5mm
 - Tightening torque: 8 Kgf.cm

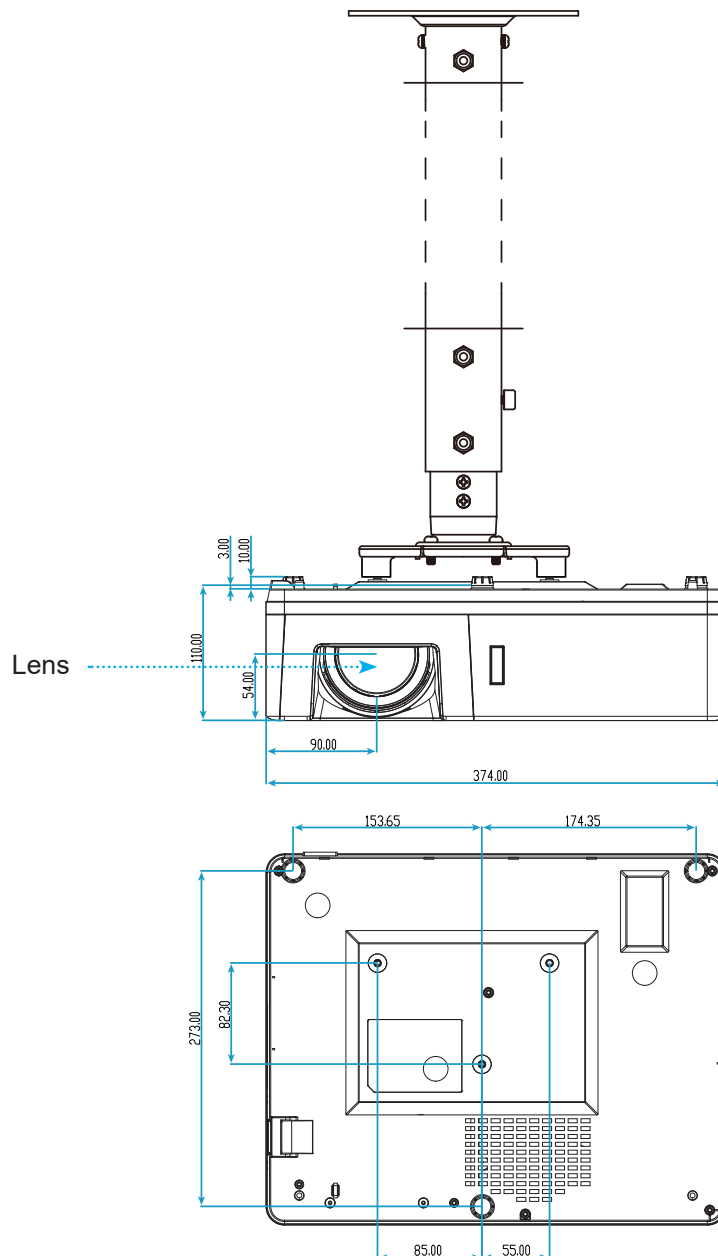

Unit: mm

Note: Please note that damage resulting from incorrect installation will void the warranty.



Warning:

- If you buy a ceiling mount from another company, please be sure to use the correct screw size. Screw size will vary depending on the thickness of the mounting plate.
- Be sure to keep at least 10 cm gap between the ceiling and the bottom of the projector.
- Avoid installing the projector near a heat source.

ADDITIONAL INFORMATION

IR remote codes

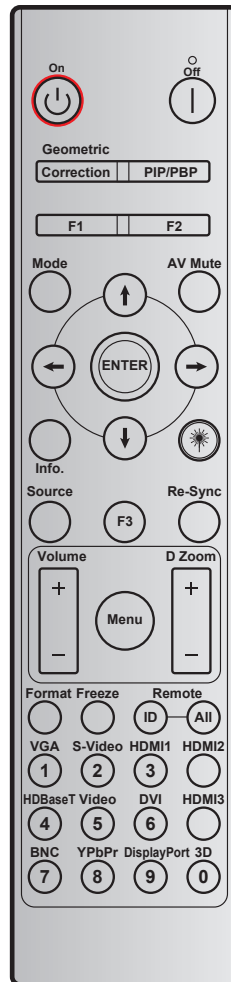

Key	Printing-key definition	Key code				Repeat
		BYTE1	BYTE2	BYTE3	BYTE4	
		customer 0	customer 1	data 0	data 1	
Power On	On	32	CD	02	#BYTE3	F1
Power Off	Off	32	CD	2E	#BYTE3	F1
Geometric Correction	Geometric Correction	32	CD	96	#BYTE3	F1
PIP/PBP	PIP/PBP	32	CD	78	#BYTE3	F1
F1	F1	32	CD	26	#BYTE3	F1
F2	F2	32	CD	27	#BYTE3	F1
Mode	Mode	32	CD	95	#BYTE3	F1
Four directional select keys (↑/↓/←/→)	Up arrow	32	CD	C6	#BYTE3	F1
	Down arrow	32	CD	C7	#BYTE3	F1
	Left arrow	32	CD	C8	#BYTE3	F1
	Right arrow	32	CD	C9	#BYTE3	F1
Enter	Enter	32	CD	C5	#BYTE3	F1
AV Mute	AV Mute	32	CD	03	#BYTE3	F1
Information	Info.	32	CD	25	#BYTE3	F1

ADDITIONAL INFORMATION







Key	Printing-key definition	Key code				Repeat
		BYTE1	BYTE2	BYTE3	BYTE4	
		customer 0	customer 1	data 0	data 1	
Laser ✨	Laser	N/A	N/A	N/A	N/A	N/A
Source	Source	32	CD	18	#BYTE3	F1
F3	F3	32	CD	66	#BYTE3	F1
Re-Sync	Re-Sync	32	CD	04	#BYTE3	F1
Volume	Volume +	32	CD	09	#BYTE3	F1
	Volume -	32	CD	0C	#BYTE3	F1
D Zoom	D Zoom +	32	CD	08	#BYTE3	F1
	D Zoom -	32	CD	0B	#BYTE3	F1
Menu	Menu	32	CD	88	#BYTE3	F1
Format	Format	32	CD	15	#BYTE3	F1
Freeze	Freeze	32	CD	06	#BYTE3	F1
Remote	ID	N/A	N/A	3201~ 3299	N/A	N/A
	All	N/A	N/A	32CD	N/A	N/A
1 / VGA	1/VGA	32	CD	8E	#BYTE3	F1
2 / S-Video	2/S-Video	32	CD	1D	#BYTE3	F1
3 / HDMI1	3/HDMI1	32	CD	16	#BYTE3	F1
HDMI2	HDMI2	32	CD	9B	#BYTE3	F1
4 / HDBaseT	4/HDBaseT	32	CD	70	#BYTE3	F1
5 / Video	5/Video	32	CD	1C	#BYTE3	F1
6	6	32	CD	19	#BYTE3	F1
HDMI3	HDMI3	32	CD	98	#BYTE3	F1
7	7	32	CD	1A	#BYTE3	F1
8 / YPbPr	8/YPbPr	32	CD	17	#BYTE3	F1
9	9	32	CD	9F	#BYTE3	F1
0 / 3D	0/3D	32	CD	89	#BYTE3	F1
F3	F3	32	CD	66	#BYTE3	F1

ADDITIONAL INFORMATION

Troubleshooting

If you experience a problem with your projector, please refer to the following information. If a problem persists, please contact your local reseller or service center.

Image problems

-  *No image appears on-screen*
- Ensure all the cables and power connections are correctly and securely connected as described in the "Installation" section.
 - Ensure the pins of connectors are not crooked or broken.
 - Ensure that the "Mute" feature is not turned on.
-  *Image is out of focus*
- Turn the focus ring clockwise or counterclockwise until the image is sharp and legible. (Please see page 18).
 - Make sure the projection screen is between the required distance from the projector. (Please refer to pages 64~66).
-  *The image is stretched when displaying 16:9 DVD title*
- When you play anamorphic DVD or 16:9 DVD, the projector will show the best image in 16: 9 format on projector side.
 - If you play the V-Stretch format DVD title, please change the format as V-Stretch in projector OSD.
 - If you play 4:3 format DVD title, please change the format as 4:3 in projector OSD.
 - Please setup the display format as 16:9 (wide) aspect ratio type on your DVD player.
-  *Image is too small or too large*
- Turn the zoom lever clockwise or counterclockwise to increase or decrease the projected image size. (Please see page 18).
 - Move the projector closer to or further from the screen.
 - Press "Menu" on the projector panel, go to "Display → Aspect Ratio". Try the different settings.
-  *Image has slanted sides:*
- If possible, reposition the projector so that it is centered on the screen and below the bottom of the screen.
-  *Image is reversed*
- Select "Setup → Projection Orientation" from the OSD and adjust the projection direction.

ADDITIONAL INFORMATION

Other problems



The projector stops responding to all controls

- If possible, turn off the projector, then unplug the power cord and wait at least 20 seconds before reconnecting power.

Remote control problems



If the remote control does not work

- Check the operating angle of the remote control is pointed within $\pm 15^\circ$ to the IR receiver on the projector.
- Make sure there are not any obstructions between the remote control and the projector. Move to within 6 m (19.7 ft) of the projector.
- Make sure batteries are inserted correctly.
- Replace batteries if they are exhausted.

ADDITIONAL INFORMATION

Warning indicators

When the warning indicators (see below) light up or flash, the projector will automatically shutdown:

- “LD” LED indicator is lit red and if “Power” indicator flashes red.
- “Temp” LED indicator is lit red and if “Power” indicator flashes red. This indicates the projector has overheated. Under normal conditions, the project can be switched back on.
- “Temp” LED indicator flashes red and if “Power” indicator flashes red.

Unplug the power cord from the projector, wait for 30 seconds and try again. If the warning indicator lights up or flashes, please contact your nearest service center for assistance.

LED lightning messages

Message	Power LED		Temp LED	LD LED
	(Red)	(White)	(Red)	(Red)
Standby state (Input power cord)	Steady light			
Power on (Warming)		Flashing (0.5 sec off / 0.5 sec on)		
Power on and LD lighting		Steady light		
Power off (Cooling)		Flashing (0.5 sec off / 0.5 sec on). Back to red steady light when cooling fan turns off.		
Error (LD failure)	Flashing			Steady light
Error (Fan failure)	Flashing		Flashing	
Error (Over temp.)	Flashing		Steady light	

- Power off:

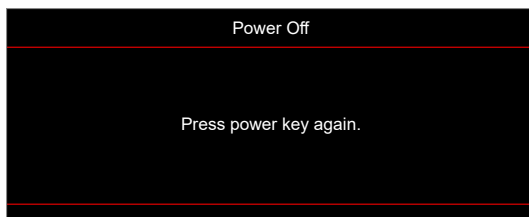

- Temperature warning:

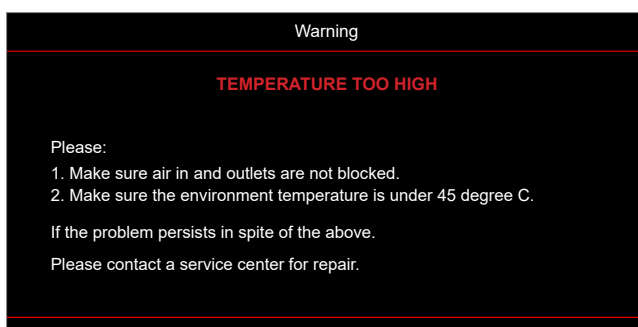

ADDITIONAL INFORMATION

Specifications

Item	Description
Technology	Texas Instrument DMD, 0.67" WUXGA DMD S600HB
Native Resolution	1920x1200
Maximum Resolution	Maximum Resolution: <ul style="list-style-type: none"> • HDMI(HDMI 2.0): 3840x2160 @60 Hz • VGA: 1920x1200 @60 Hz
Lens	Throw ratio <ul style="list-style-type: none"> • WUXGA 1.6x lens model: TR 1.2 to 1.92 (tolerance $\pm 3\%$) • WUXGA Short Throw model: TR 0.58 (tolerance $\pm 3\%$)
	F/#: <ul style="list-style-type: none"> • WUXGA 1.6x lens model: 2.3 to 3 • WUXGA Short Throw model: 2.75
	Focal length: <ul style="list-style-type: none"> • WUXGA 1.6x lens model: 17.63 to 27.9 mm • WUXGA Short Throw model: 8.51 mm
	Zoom range: <ul style="list-style-type: none"> • WUXGA 1.6x lens model: 1.6x • WUXGA Short Throw model: Fixed Zoom
Lens Shift Range	WUXGA 1.6x lens model: <ul style="list-style-type: none"> • Vertical: 100% to 120% $\pm 3\%$; • Horizontal: -10% to +10% $\pm 3\%$
	WUXGA Short Throw model: <ul style="list-style-type: none"> • Vertical: 100% to 110% $\pm 3\%$; • Horizontal: -4% to +4% $\pm 3\%$
Image size	WUXGA 1.6x lens model: <ul style="list-style-type: none"> • 31.5 to 301.8" (mechanism travel(wide))
	WUXGA Short Throw model: <ul style="list-style-type: none"> • 30 to 300" (mechanism travel)
Projection distance	WUXGA 1.6x lens model: <ul style="list-style-type: none"> • 1.3m to 7.8m (mechanism travel)
	WUXGA Short Throw model: <ul style="list-style-type: none"> • 0.38m to 3.75m (mechanism travel)
I/Os	Input interface: <ul style="list-style-type: none"> • HDMI in V2.0 x2; HDBaseT x1 • VGA in x2; Audio in 1 x1, Audio in 2 x1 • Composite Video in x1
	Output interface: <ul style="list-style-type: none"> • HDMI out x1, Audio out x1, USB Power (5V/1.5A), 3D Sync out x1
	Control interface: <ul style="list-style-type: none"> • LAN (RJ-45) x1, RS232 x1, 12V out x1
Colour	1073.4 Million color
Scan rate	Horizontal scan rate: <ul style="list-style-type: none"> • 15 KHz to 140 KHz
	Vertical scan rate: <ul style="list-style-type: none"> • 24 Hz to 140 Hz
Speaker	15W x2

ADDITIONAL INFORMATION

Item	Description
Power consumption	Typical: (bright mode) <ul style="list-style-type: none"> • 366W ±15% @110VAC • 355W ±15% @220VAC
	Typical: (ECO mode): <ul style="list-style-type: none"> • 240W ±15% @110VAC • 233W ±15% @220VAC
Input current	<ul style="list-style-type: none"> • AC 3.7A @110V • AC 1.85A @220V
Installation orientations	360° projection + portrait
Dimensions (W x D x H)	Without feet: <ul style="list-style-type: none"> • 374 mm(W) x 302 mm(D) x 107 mm(H) (14.72 x 11.89 x 4.21 inches)
	With feet: <ul style="list-style-type: none"> • 374 mm(W) x 302 mm(D) x 117 mm(H) (14.72 x 11.89 x 4.60 inches)
Weight	6.3 kg±0.5 kg
Environmental	Operating in 0° to 40°C, 10% to 85% humidity (non-condensing)

Note: All specifications are subject to change without notice.



ADDITIONAL INFORMATION

Optoma global offices

For service or support, please contact your local office.



USA

Optoma Technology, Inc.
47697 Westinghouse Drive.
Fremont, Ca 94539

 888-289-6786
 510-897-8601
 services@optoma.com



Canada

Optoma Technology, Inc.
47697 Westinghouse Drive.
Fremont, Ca 94539

 888-289-6786
 510-897-8601
 services@optoma.com



Latin America

Optoma Technology, Inc.
47697 Westinghouse Drive.
Fremont, Ca 94539

 888-289-6786
 510-897-8601
 services@optoma.com



Europe

Unit 1, Network 41, Bourne End Mills
Hemel Hempstead, Herts,
HP1 2UJ, United Kingdom
www.optoma.eu
Service Tel : +44 (0)1923 691865

 +44 (0) 1923 691 800
 +44 (0) 1923 691 888
 service@tsc-europe.com



Benelux BV

Randstad 22-123
1316 BW Almere
The Netherlands
www.optoma.nl

 +31 (0) 36 820 0252
 +31 (0) 36 548 9052



France

Bâtiment E
81-83 avenue Edouard Vaillant
92100 Boulogne Billancourt, France

 +33 1 41 46 12 20
 +33 1 41 46 94 35
 savoptoma@optoma.fr



Spain

C/ José Hierro,36 Of. 1C
28522 Rivas VaciaMadrid,
Spain

 +34 91 499 06 06
 +34 91 670 08 32



Deutschland

Am Nordpark 3
41069 Mönchengladbach
Germany

 +49 (0) 2161 68643 0
 +49 (0) 2161 68643 99
 info@optoma.de

Scandinavia

Lerpeveien 25
3040 Drammen
Norway

 +47 32 98 89 90
 +47 32 98 89 99
 info@optoma.no

PO.BOX 9515
3038 Drammen
Norway

Korea

<https://www.optoma.com/kr/>

Japan



<https://www.optoma.com/jp/>

Taiwan

<https://www.optoma.com/tw/>

China

Room 2001, 20F, Building 4,
No.1398 Kaixuan Road,
Changning District
Shanghai, 200052, China

 +86-21-62947376
 +86-21-62947375
www.optoma.com.cn

Australia

<https://www.optoma.com/au/>

